

USER MANUAL

METER FOR ELECTRICAL INSTALLATION PARAMETERS

MPI-535

MPI-535

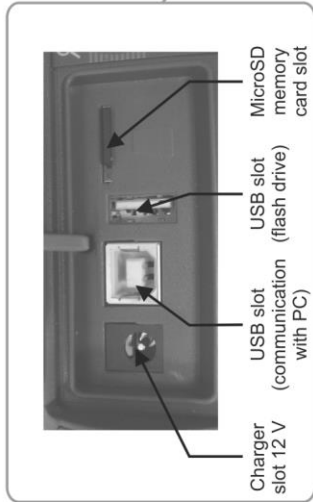

Clamps slots R_E - measurement of earth systems

Measuring terminals

ES socket for measuring earth resistance and soil resistivity



Starting the measurement procedure

Contact electrode

Touchscreen

- Back
- Save
- Show last measurement
- Return to main menu
- Select item
- Show more icons
- Add item
- Edit item
- Search
- Remove item
- Close menu



USER MANUAL

METER FOR ELECTRICAL INSTALLATION PARAMETERS MPI-535



**SONEL S.A.
Wokulskiego 11
58-100 Świdnica
Poland**

Version 1.10 05.10.2022

MPI-535 meter is a modern, easy in use and safe measuring device. Please acquaint your-self with this manual in order to avoid measuring errors and prevent possible problems in operation of the meter.

CONTENTS

1 Safety	6
2 Main menu	7
2.1 Meter settings.....	8
2.1.1 Setting date and time.....	9
2.1.2 Automatic shutdown	10
2.1.3 Display parameters.....	11
2.2 Settings of measurements	12
2.2.1 Sub-menu Measurement Settings.....	12
2.2.2 Sub-menu Edit fuses	14
a. Adding fuse characteristics	14
b. Adding fuses.....	19
2.3 Communication	21
2.3.1 USB communication	21
2.3.2 Connection to a Wi-Fi network.....	21
2.3.3 E-mail settings	21
2.4 Update	22
2.4.1 Update via USB.....	22
2.4.2 Update via Wi-Fi.....	22
2.5 Regional settings	23
2.6 Meter information	24
3 Measurements	25
3.1 Diagnostics performed by the meter – limits.....	26
3.2 Measurement of alternating voltage and frequency.....	26
3.3 Checking the correctness of PE (protective earth) connections	27
3.4 Fault loop parameters	28
3.4.1 Settings of measurements	28
3.4.2 Fault loop parameters in the L-N and L-L circuits.....	30
3.4.3 Fault loop parameters in the L-PE circuit.....	33
3.4.4 Fault loop impedance in L-PE circuit protected with a residual current device (RCD)	36
3.4.5 Prospective short-circuit current	39
3.4.6 Measurement of fault loop impedance in IT networks	40
3.5 Voltage drop.....	41
3.6 Resistance-to-earth.....	43
3.6.1 Settings of measurements	43
3.6.2 Earth resistance measurement with 3-pole method (R_{E3P}).....	44
3.6.3 Earth resistance measurement with 4-wire method (R_{E4P}).....	48
3.6.4 Earth resistance measurement with 3-pole method with additional clamp (R_{E3P+C})	52
3.6.5 Earth resistance measurement with two-clamp method (2C)	56
3.7 Soil resistivity	59
3.7.1 Settings of measurements	59
3.7.2 Main elements of the screen.....	60
3.7.3 Soil resistivity measurements (ρ)	61
3.8 RCD parameters	65
3.8.1 Settings of measurements	65
3.8.2 RCD tripping current.....	68
3.8.3 RCD tripping time	71
3.8.4 Measurements in IT networks.....	74
3.9 Automatic measurements of RCD parameters.....	75
3.9.1 Setting automatic measurements of RCD parameters	75
3.9.2 Automatic measurement of RCDs.....	76

3.10	Insulation resistance	81
3.10.1	Settings of measurements	81
3.10.2	Measurement using probes.....	85
3.10.3	Measurements using UNI-Schuko adapter (WS-03 and WS-04).....	87
3.10.4	Measurements using AutoISO-1000c	90
3.11	Low-voltage resistance measurement	94
3.11.1	Resistance measurement	94
3.11.2	Measurement of resistance of protective conductors and equipotential bonding with ± 200 mA current.....	97
3.12	Phase sequence	101
3.13	Motor rotation direction	102
3.14	Illuminance.....	104
4	Auto measurements	106
4.1	Proceeding auto measurements	106
4.2	Creating measurement procedures.....	108
5	Memory of the meter.....	110
5.1	Memory settings.....	110
5.2	Structure of the Memory.....	111
5.2.1	Fundamentals of navigating the Memory menu.....	112
5.2.2	Adding a new measurements tree.....	114
5.3	Entering the measurement result.....	119
5.4	Viewing saved measurements	120
5.5	Sharing recorded measurements.....	122
5.6	Searching the meter memory.....	123
6	Power supply.....	124
6.1	Monitoring of the battery charge status.....	124
6.2	Replacing rechargeable batteries	124
6.3	Charging the rechargeable batteries.....	125
6.4	General rules for using Li-Ion rechargeable batteries.....	126
7	Cleaning and maintenance	127
8	Storage.....	127
9	Dismantling and utilisation.....	127
10	Technical data	128
10.1	Basic data	128
10.1.1	Measurement of alternating voltages (True RMS).....	128
10.1.2	Frequency measurement	128
10.1.3	Measurement of fault loop impedance Z_{L-PE} , Z_{L-N} , Z_{L-L}	128
10.1.4	Measurement of fault loop impedance $Z_{L-PE[RCD]}$ (without triggering of RCD)	129
10.1.5	Measurement of parameters of RCD	130
10.1.6	Measurement of resistance-to-earth R_E	133
10.1.7	Low-voltage measurement of continuity of circuit and resistance.....	134
10.1.8	Measurement of insulation resistance.....	135
10.1.9	Light measurements	136
10.1.10	Phase sequence.....	137
10.1.11	Motor rotation	137
10.2	Other technical data	137
10.3	Additional data	138

10.3.1	Additional uncertainties according to IEC 61557-2 (R_{iso}).....	138
10.3.2	Additional uncertainties according to IEC 61557-3 (Z).....	138
10.3.3	Additional uncertainties according to IEC 61557-4 ($R \pm 200$ mA).....	138
10.3.4	Additional uncertainties of earth resistance measurement (R_E).....	138
10.3.5	Additional uncertainties according to IEC 61557-6 (RCD).....	139
10.4	List of reference standards	139
11	Accessories.....	140
11.1	Standard accessories	140
11.2	Optional accessories.....	141
12	Positions of the meter's cover.....	145
13	Manufacturer	145
14	Laboratory services.....	146

1 Safety

MPI-535 meter is designed for performing check tests of protection against electric shock in AC mains systems and recording the parameters of electric mains. The meter is used for making measurements and providing results to determine safety of electrical installations. Therefore, in order to provide conditions for correct operation and accuracy of obtained results, the following recommendations must be observed:

- Before you proceed to operate the meter, acquaint yourself thoroughly with the present manual and observe the safety regulations and specifications provided by the producer.
- Any application that differs from those specified in the present manual may result in a damage to the device and constitute a source of danger for the user.
- MPI-535 meters must be operated only by appropriately qualified personnel with relevant certificates authorising the personnel to perform works on electric systems. Operating the meter by unauthorised personnel may result in damage to the device and constitute a source of danger for the user.
- Using this manual does not exclude the need to comply with occupational health and safety regulations and with other relevant fire regulations required during the performance of a particular type of work. Before starting the work with the device in special environments, e.g. potentially fire-risk/explosive environment, it is necessary to consult it with the person responsible for health and safety.
- It is unacceptable to operate:
 - ⇒ a damaged meter which is completely or partially out of order,
 - ⇒ a meter with damaged insulation,
 - ⇒ a meter stored for an excessive period of time in disadvantageous conditions (e.g. excessive humidity). If the meter has been transferred from a cool to a warm environment with a high level of relative humidity, do not start measurements until the meter is warmed up to the ambient temperature (approximately 30 minutes).
- If the battery is discharged to a level preventing further measurements, the meter displays an appropriate message and then turns off.
- Battery spill and damage to the meter may occur if discharged batteries are left in the meter.
- Before measurements may commence, make sure the leads are connected to the appropriate measurement sockets.
- Do not operate a meter with an open or incorrectly closed battery (accumulator) compartment or power it from other sources than those specified in the present manual.
- **Riso** meter inputs are electronically protected against overloads (caused by e.g. connecting the meter to a live circuit) up to 463 V RMS for 60 seconds.
- Repairs may be performed only by an authorised service point.



NOTE!

Only accessories for a given device should be used, as listed in **section 11**. Using other accessories may cause damage to measuring terminals, introduce additional measurement error and create a risk for the user.



Due to continuous development of the meter's software, the actual appearance of the display, in case of some of the functions, may slightly differ from the display presented in this operating manual.

2 Main menu

The main screen is available:

- after the meter has been turned on,
- at any time after the  icon has been selected on the display (does not apply to the recorder).

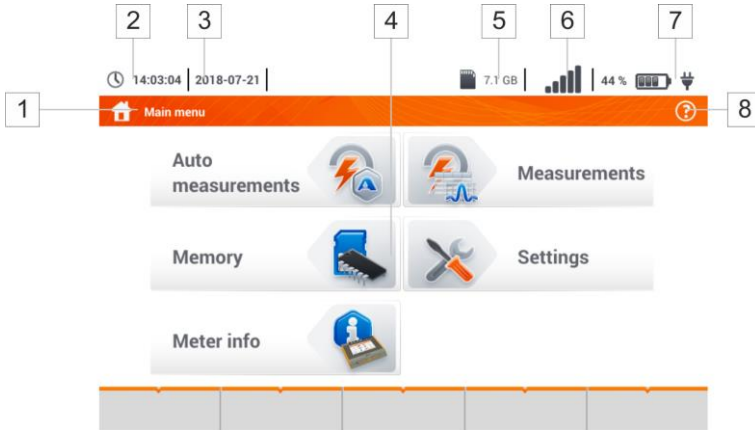

Fig. 2.1 Main elements of the screen

1 Name of the active menu

The fact of introducing a change that has not been saved yet is indicated by the * symbol in the screen header.



2 Time

3 Date

4 Main screen

5 Free space on the memory card

If the card is not in the slot, the icon on the screen is crossed out.

6 Wireless network signal strength

7 Battery discharge indicator

8 Active menu help

- Visualisation of connection systems
- Explanation of icons

Touching a selected main menu item redirects to the sub-menu. Available options:

- **Settings** – going to the settings of the main functions and parameters of the meter,
- **Measurements** – Selecting the measurement function. The description of individual functions is provided in **section 3**,

- **Memory** – viewing and managing the saved measurement results. A detailed description of the function is provided in **section 5**,
- Meter information

2.1 Meter settings

The **date, time** and display **brightness** can be set from the **Meter settings** screen level.

1  In the main menu select **Settings**.

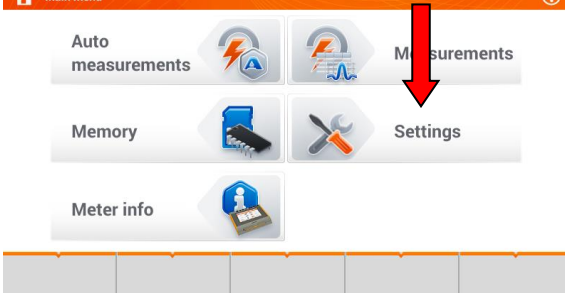

2  Select **Meter settings**

3  Parameters to change
 ⇒ Date and time (**section 2.1.1**)
 ⇒ Auto off (**section 2.1.2**)
 ⇒ Display (**section 2.1.3**)

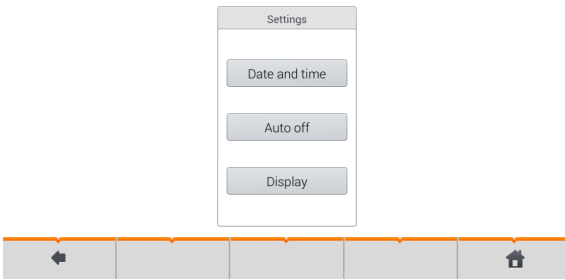

2.1.1 Setting date and time

1

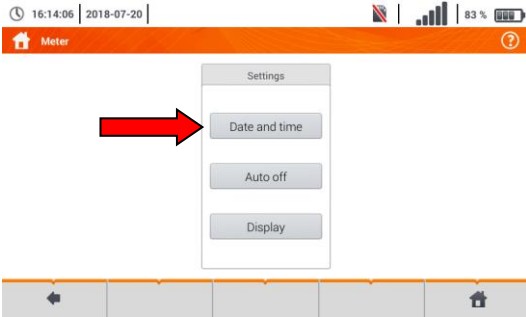

Select **Date and time**.

2

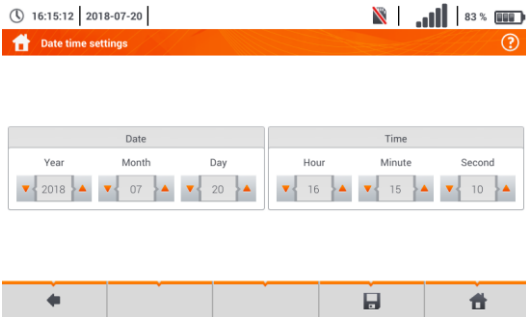

Touch the appropriate icon to modify the selected parameter:

▲ value increase by 1,

▼ value decrease by 1,

2018 touching opens the field for manual entering of the value (step 3).

3



Delete the existing entry and enter the required value manually.

Functions of icons

✖ reject the changes and return to step 2

✔ accept changes and go to step 4

4

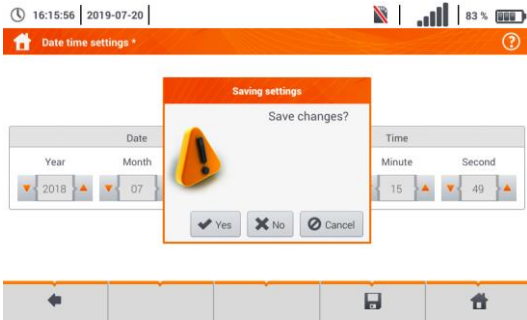

Description of function icons

- ← return to the previous screen
After touching the icon you may be prompted to save or reject changes (figure):
Yes – accept selection,
No – reject changes,
Cancel – cancel the action
- saving changes
- return to the main menu

2.1.2 Automatic shutdown

1

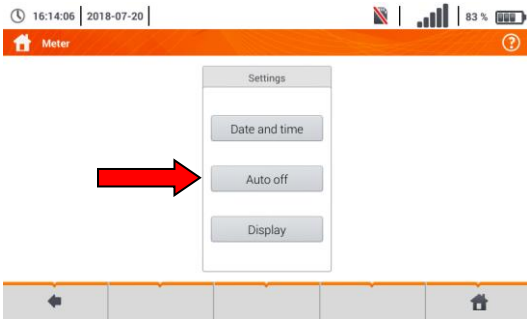

Select **Auto off**.

2

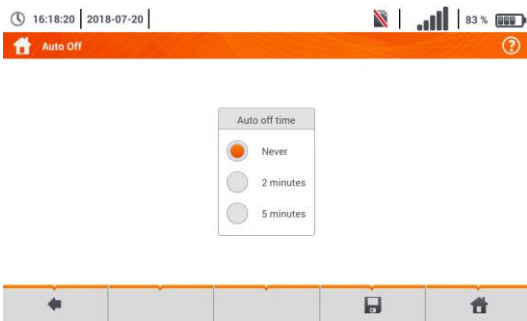

Select the required option.

3

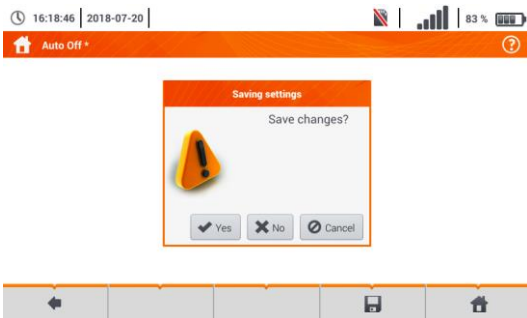

Description of function icons

- ← return to the previous screen
After touching the icon you may be prompted to save or reject changes (figure):
Yes – accept selection,
No – reject changes,
Cancel – cancel the action
- saving changes
- return to the main menu

2.1.3 Display parameters

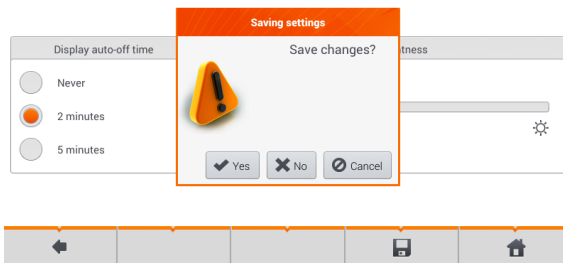
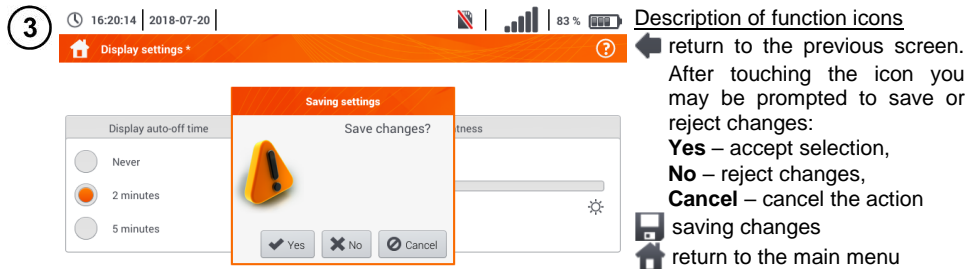
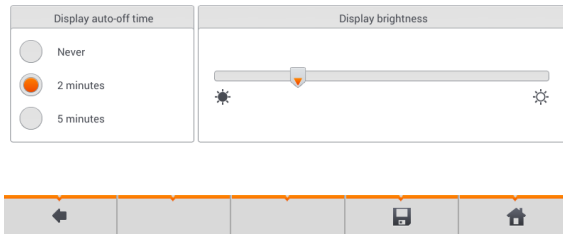
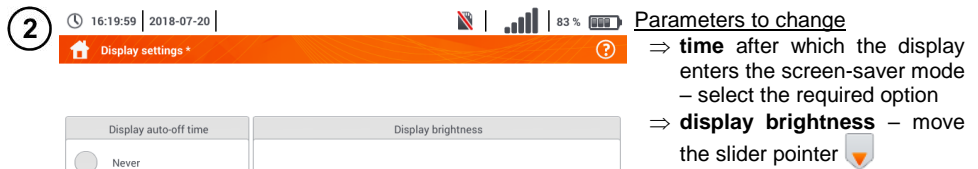
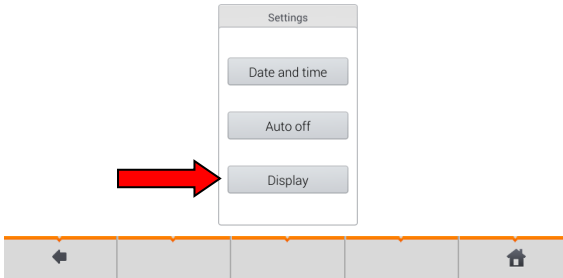

2.2 Settings of measurements

From the **Measurement settings** menu it is possible to edit:

- network parameters,
- fuse definitions.

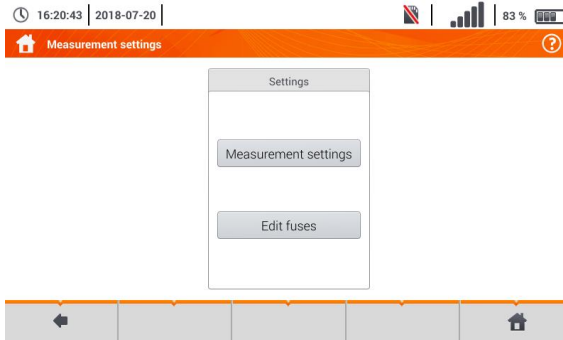

2.2.1 Sub-menu Measurement Settings

The option of **Measurement settings** consists of:

- mains rated voltage,
- network frequency,
- manner of presentation of short-circuit loop result,
- type of mains for the tested object,
- system of units,
- memory settings (auto-incrementing memory cells),
- auto measurements timer,
- RCD EV measurement standard.

Before the measurements select the **type of mains** from which the tested object is powered. Then select **the mains rated voltage U_n** (110/190 V, 115/200 V, 127/220 V, 220/380 V, 230/400 V or 240/415 V). This voltage value is used for calculating the values of prospective short-circuit current.

Determination of **network frequency** that is the source of potential interferences is necessary in order to select a proper measuring signal frequency in resistance-to-earth measurements. This selection ensures optimum interference filtering. The meter is designed for filtration of interferences generated by 50 Hz and 60 Hz networks.

RCD EV measurement standard defines the parameters for measuring RCD protectors dedicated to the field of electromobility and photovoltaics.

Setting **Autoincrementing** as active (→) causes each saved measurement (**section 5.3**) to be placed in an automatically created new measurement point (**section 5.2.2** step 14).

Auto measurements timer determines the time interval of starting subsequent steps of the measurement procedure.

1



- Expand the selection list using the  icon.
- Select the required parameter value.



Selection and modification options

- U_n voltage
 - ⇒ 110/190 V
 - ⇒ 115/200 V
 - ⇒ 127/220 V
 - ⇒ 220/380 V
 - ⇒ 230/400 V
 - ⇒ 240/415 V
- Frequency f_n
 - ⇒ 50 Hz
 - ⇒ 60 Hz
- Fault loop measurement form
 - ⇒ I_k – prospective short-circuit current
 - ⇒ Z_s – fault loop impedance
- System type
 - ⇒ TN/TT
 - ⇒ IT
- System units, of
 - ⇒ metric
 - ⇒ imperial
- Autoincrementing
 - ⇒ enabled
 - ⇒ disabled
- Auto measurements timer
 - ⇒ Turn off
 - ⇒ 0...5 s

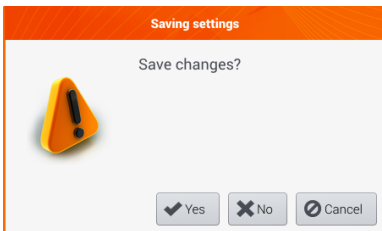
2



Description of function icons

-  return to the previous screen. After touching the icon you may be prompted to save or reject changes:
 - Yes** – accept selection,
 - No** – reject changes,
 - Cancel** – cancel the action
-  saving changes
-  returning to the main menu

2.2.2 Sub-menu Edit fuses

On the **Fuse base** screen the following parameters of circuit breakers can be defined and edited:

- manufacturer,
- model (type) of fuse,
- characteristic of fuse.

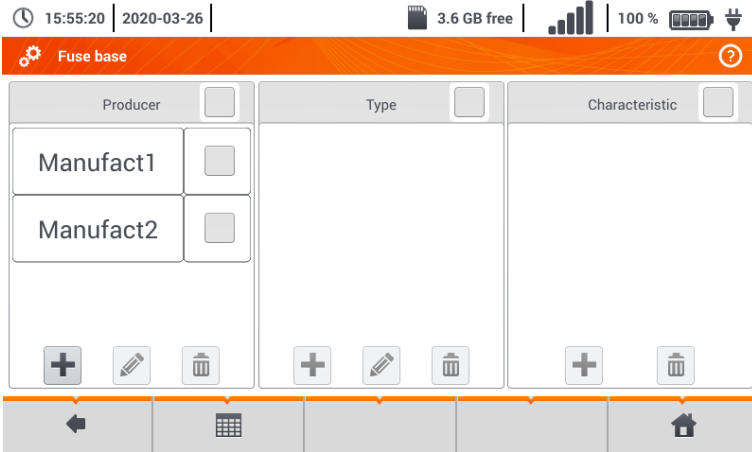

a. Adding fuse characteristics

1

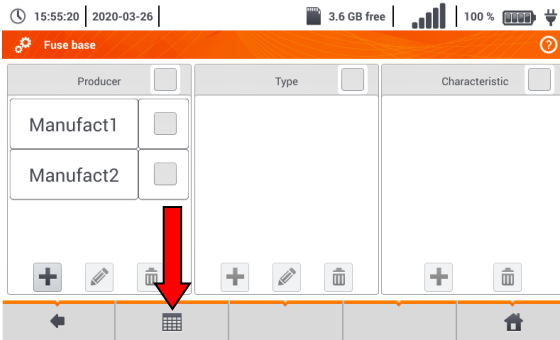

- Select the  icon.

- A menu will appear for adding time-current characteristics of fuses.

2

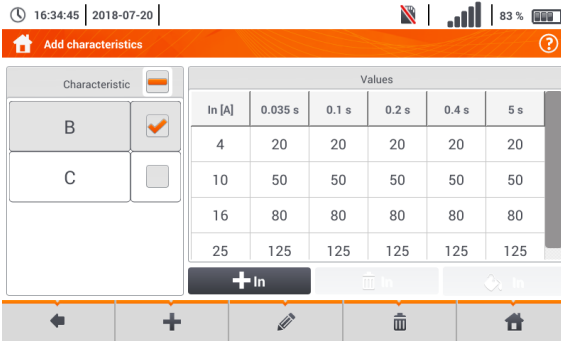

Available options

- adding characteristics for the selected fuse rated current.
- removing characteristics for the selected fuse rated current.
- pasting the set value for records in the whole row or table.

Description of function icons

- inactive characteristic
- active characteristic
- adding a new characteristic
- editing the name of the active characteristic
- removing the active characteristic
- returning to the previous screen
- going to the main menu

3



To create a new characteristic:

- select the **+** icon,
- touch the name selection field.

4



Enter the name from the touch keypad (holding certain buttons for a longer time triggers Polish characters).

Functions of icons

- rejecting changes and returning to step 3
- accepting changes and going to step 5

5

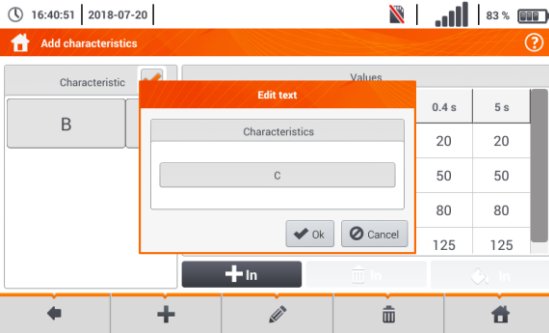



Description of function icons

- Ok** – accept the name
- Cancel** – cancel the action



6

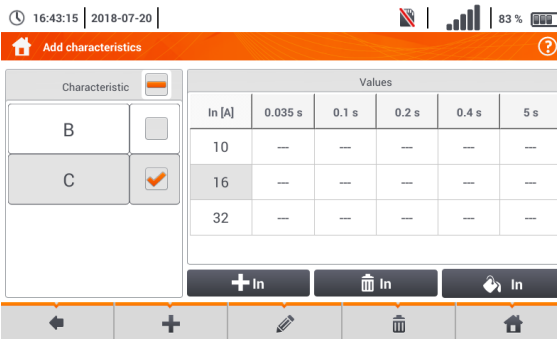

- Activate the created characteristic .
- Add rated fuse current using icon .
- Editing fuse data proceed as in steps [3](#) [4](#) [5](#).

7



- To activate a row of data, select any item in the row.
- Icons   will be activated.

8

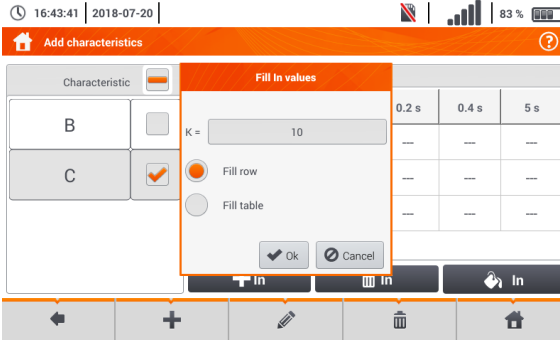

After selecting , the following options are available:

- ⇒ **parameter K** – setting the multiplication factor of fuse rated current (parameter of the time-current characteristic),
- ⇒ **fill row** – copying K value to the selected row,
- ⇒ **fill table** – copying K value to all records.

- Touch the K parameter edit field.
- Enter the parameter values as in step 4.

Description of function icons

Ok – accept selection

Cancel – cancel changes

9

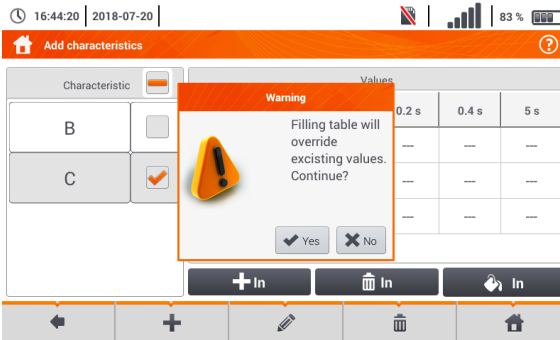

You will be prompted to conform the selection.

Description of function icons

Yes – accept selection

No – reject changes

10

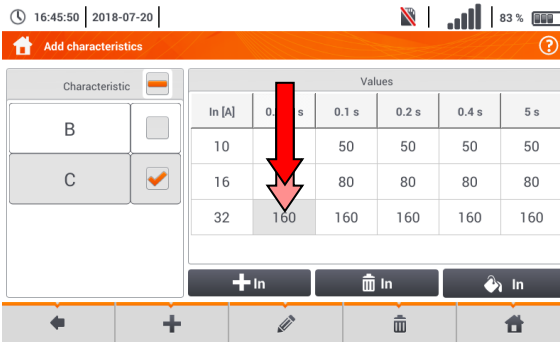

To change the contents of a selected cell, touch it **twice**.



On-screen keyboard will appear. Delete the existing entry and enter the required one.

Functions of icons

- ✖ reject changes and return to the menu for adding characteristics
- ✔ accept changes and return to the menu for adding characteristics



Select the icon and return to the fuse base menu.

b. Adding fuses

1

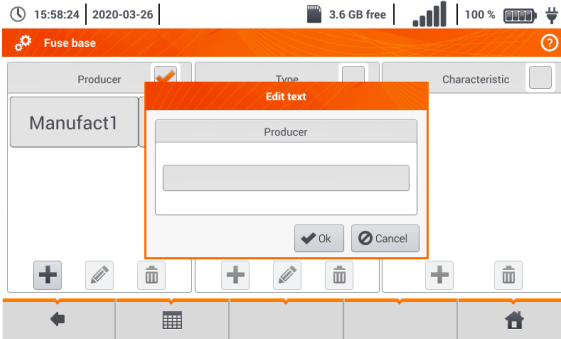

Add a producer.

- In **Producer** column press **+**.
- Touch the name input field.
- Enter the name from the touch keypad (holding certain buttons for a longer time triggers additional characters).

Functions of icons

- ✖ reject the changes
- ✔ accept changes and go to step 2

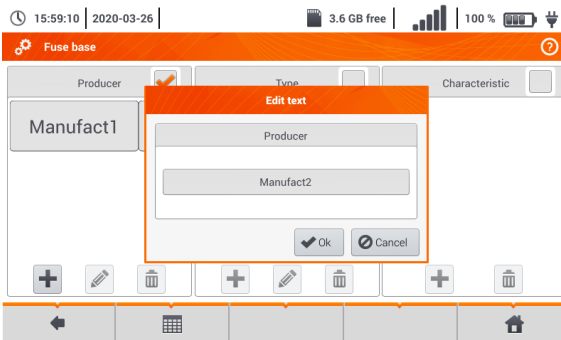
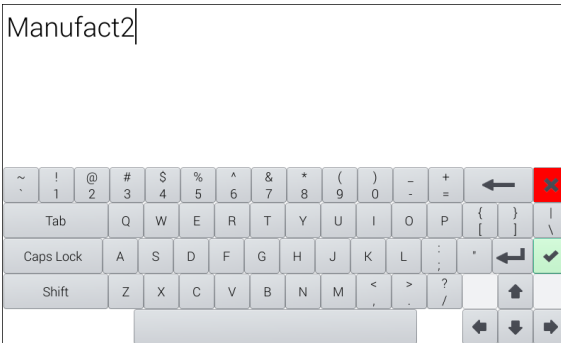

2

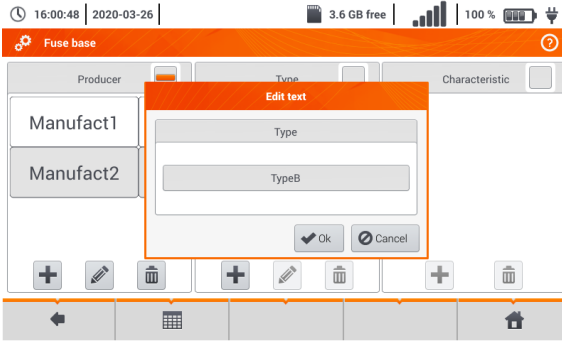

- Select the producer.
- In **Type** column press **+**.
- Enter the fuse model as in step 1.

3



- Highlight the required type of fuse.
- In the **Characteristic** column press **+**.
- Enter the fuse characteristic from list.

4

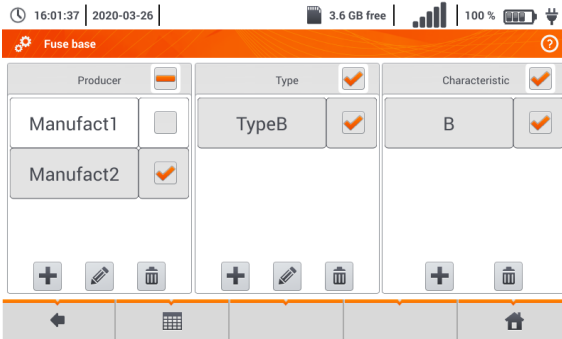

Description of function icons

- record inactive
- record active
- +** add new record
- edit active record name
- remove active record
- return to the previous screen
- return to the main menu

2.3 Communication

2.3.1 USB communication

The B-type USB port built-in in the meter is used to connect the meter to the computer in order to download the data stored in its memory. The data may be downloaded and read through the software provided by the manufacturer.

- **Sonel Reader** – the software is used to retrieve the data saved from the meter memory. In addition, it enables data transfer to the PC, data saving in popular formats and printing.
- **Sonel Reports PLUS** – supports creation of documentation after testing of electrical installation. Software communicates with Sonel test instruments, download data from memory of test instrument and creates necessary documentation.

Detailed information is available from the manufacturer and distributors.

- 1 Connect the cable to the USB port of the computer and the USB slot of the meter.
- 2 Start the program.



Current versions of software may be found at website www.sonel.com in section **Download**.

2.3.2 Connection to a Wi-Fi network

- 1 Go to **Settings ► Communication settings ► Wi-Fi**.
- 2 Turn on Wi-Fi (the Wi-Fi status icon  should appear in the top bar).
- 3 Select a network with Internet access from the list. Touch it twice and - if it is password-protected - enter the password. To log out of the network, also tap it twice.
- 4 Select **Ok** and check that the meter is connected to the network. The Wi-Fi status icon will then indicate the signal strength.

2.3.3 E-mail settings

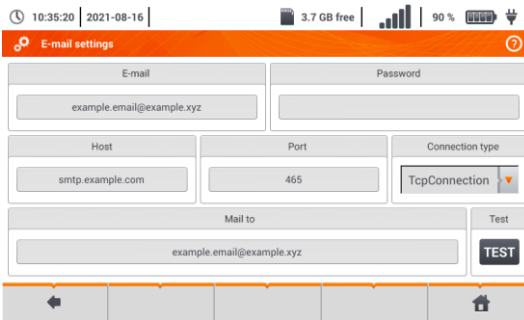

- Go to **Settings ► Communication settings ► E-mail settings**.
- Fill the fields on the screen:
 - o parameters of the outbox,
 - o target mailbox address.
- Press **TEST** to send a test email.



The function works with selected email providers. The list of suppliers is available on the manufacturer's website.

2.4 Update



NOTE!

- Before you proceed to software update, charge the accumulators.
- Do not switch off the meter while updating.

2.4.1 Update via USB

- 1 The update file can be downloaded from the manufacturer's website (www.sonel.com).
- 2 Save the file to a USB drive. The memory must have the FAT32 file system.
- 3 Select **Settings ► Update** to open the update menu.

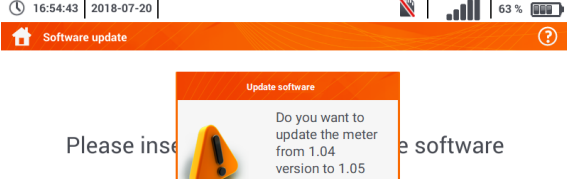
- 4  • Insert the USB memory in the Type A USB port in the meter. The information screen will appear.
• To start the update process, select **Ok** in the information window.



Alternatively, you can press the **Update via Wi-Fi** button. Then follow the procedure described in **sec. 2.4.2**.

2.4.2 Update via Wi-Fi

- 1 Connect to the Wi-Fi network according to **sec. 2.3.2**.
- 2 Choose one of the following.
 - Go to **Settings ► Software update** and select **Update via Wi-Fi**.
 - Restart the meter.
- 3 The device will automatically check if a software update is available. If it is, a window is displayed asking the user to accept the update.
- 4 To start the update process, select **Ok** in the information window.



Security features inside some networks may prevent the meter from being able to connect to the manufacturer's server with updates – then the following message will be displayed: **Unable to update Wi-Fi...**

2.5 Regional settings

1

09:48:49 | 2018-07-21



Regional settings

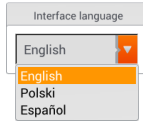

- Select **Settings** ► **Regional** to open the language settings menu.
- Expand the list of languages to select from.
- Select the required language.

Description of function icons

- ◀ return to the previous screen (you may be prompted to save or reject changes)
- 💾 saving changes
- 🏠 returning to the main menu

2

09:49:14 | 2018-07-21



Regional settings *

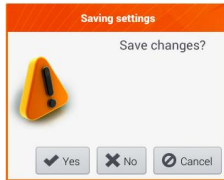

If the changes have not been saved or the ◀ icon was selected, a prompt will appear to confirm the selection.

Description of function icons

- Yes** – accept selection
- No** – reject selection
- Cancel** – cancel the action

2.6 Meter information

1 14:03:04 | 2018-07-21 | 7.1 GB | 44% | Select **Meter info** in the main menu.

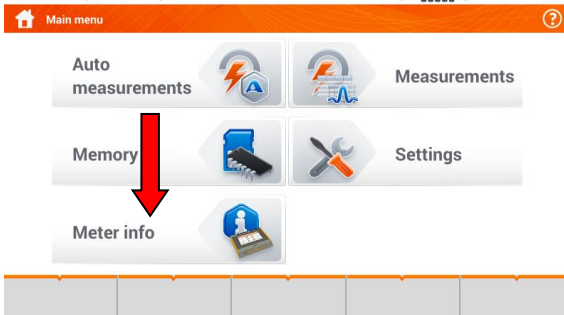

2 15:10:30 | 2019-01-24 | 47% | The menu contains information on the manufacturer and the meter.



Description of function icons

← return to the previous screen (you may be prompted to save or reject changes)

ⓘ display detailed information

🏠 return to the main menu

3 15:10:42 | 2019-01-24 | 47% | The screen after selecting icon ⓘ.

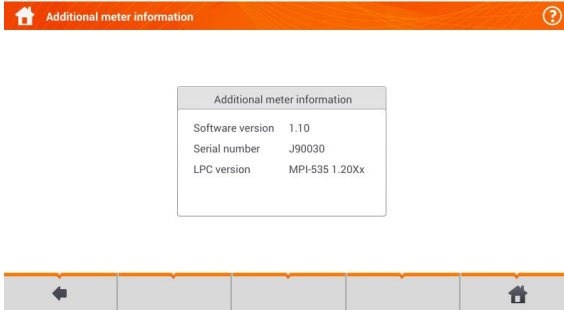

3 Measurements

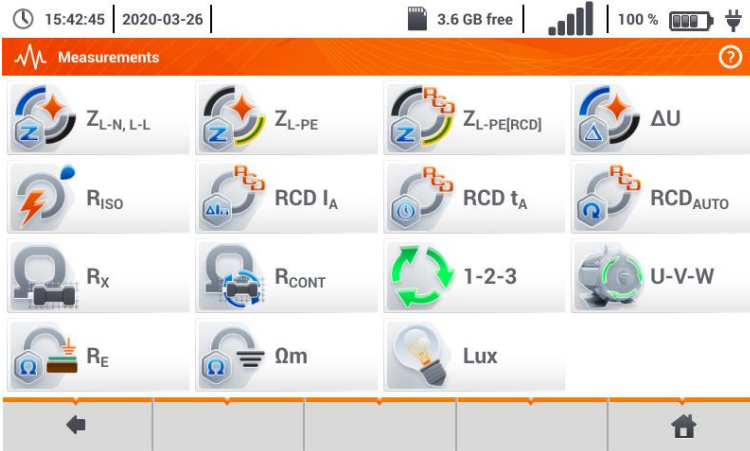

The following tests are available from the **Measurements** menu:

- fault loop impedance (**Z_{L-N}**, **Z_{L-PE}**, **Z_{L-PE}[RCD]** with RCD),
- voltage drop **ΔU**,
- insulation resistance **R_{ISO}**,
- RCD efficiency (operating current **RCD I_A**, operate time **RCD t_A** and automatic measurements),
- resistance **R_x**,
- continuity of connections **R_{CONT}**,
- phase sequence **1-2-3**,
- direction of motor rotation **U-V-W** ,
- resistance-to-earth **R_E**,
- soil resistivity **Ω_m**,
- illuminance **Lux**.



WARNING

During measurements (fault loop, RCD), do not touch conductive accessible or foreign parts of the tested electrical installation.



- The content of this chapter should be thoroughly familiarized with. It describes the **meter circuits**, the **methods of measurements** and basic principles concerning **interpretation of measurement results**.
- A progress bar is displayed during long measurements.
- The result of the last measurement is displayed until:
 - next measurement starts,
 - measurement parameters are changed,
 - measurement function is changed,
 - the meter is switched off.
- The last measurement can be recalled using the  icon.



3.1 Diagnostics performed by the meter – limits

The meter is able to assess whether the measurement result is within acceptable limits for the selected safety device or the limit value. The user may set a limit, the threshold value which should not be exceeded by the result. It is possible for all measurement functions except for:

- RCD measurements (I_A , t_A) for which the limits are permanently enabled,
- fault loop measurements, where the limit is determined indirectly by selecting a suitable overcurrent protection for which standard limits are assigned,
- the recorder.

For the measurements of insulation resistance and light the limit is the **minimum** value. For measurements of fault loop impedance, earth resistance, resistance of protective conductors and equipotential bonding - it is the **maximum** value.

The limits are set in the relevant measurement menu. After each measurement the meter displays the symbols:

-  the result is within the set limits,
-  the result is outside the set limits,
-  assessment of the result correctness not possible. The symbol is displayed, when for example the result is not available (e.g. measurement in progress, or no measurement has been performed)

the method for setting limits is described in the sections describing the measurement data.

3.2 Measurement of alternating voltage and frequency

The meter measures and displays alternating voltage and network frequency in the selected measurement functions in accordance with the table below.

Measuring function	U	f
Z _{L-N}	•	•
Z _{L-PE}	•	•
Z _{L-PE[RCD]}	•	•
R _{ISO}	•	
RCD I _A	•	•
RCD t _A	•	•
R _x		
R _{CONT}		
Phase sequence	•	
Motor rotation	•	
Resistance-to-earth R _E	•	
Soil resistivity	•	
Illuminance		

3.3 Checking the correctness of PE (protective earth) connections

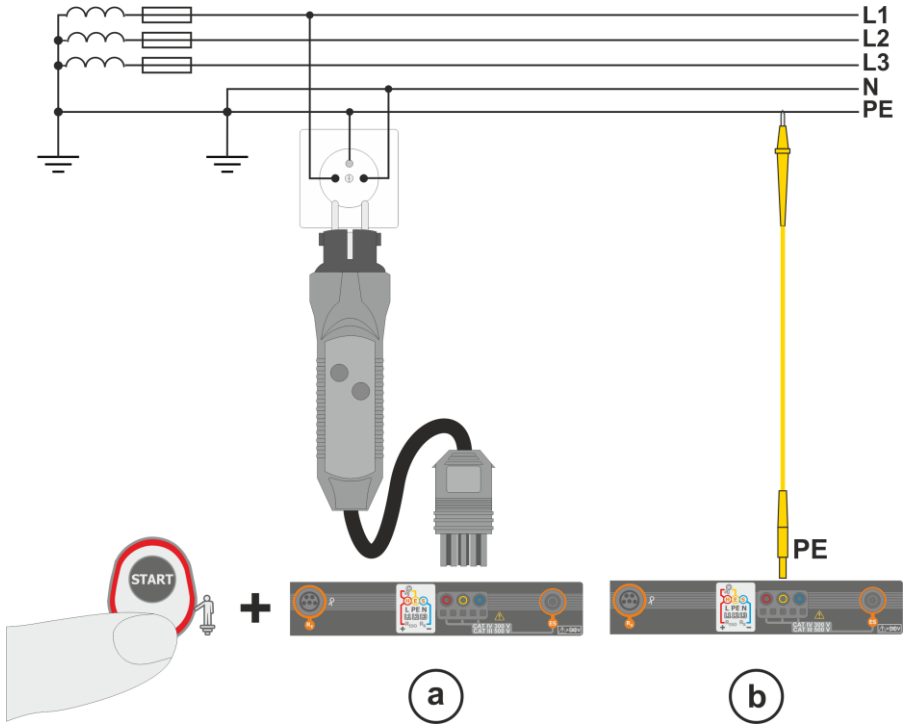

When the meter is connected as in the drawing, touch the contact electrode and wait for about **1 second**. If voltage is detected on the PE conductor, the device:

- will display text **PE!** (installation error, the PE lead connected to the phase conductor) and
- will generate a continuous audio signal

This option is available for all measuring functions that apply to residual current devices (RCD) and fault loop **except Z_{L-N}, L-L measurement**.



WARNING

When phase voltage is detected on PE lead, measurements must be immediately stopped and a fault in the installation must be removed.



- Make sure to stand on non-insulated ground when measuring. Insulated ground may cause an incorrect test result.
- If the voltage on the PE conductor exceeds the acceptable limit value (approx 50 V), the meter will signal the fact.
- If the IT network has been selected in **section 2.2.1** step **①**, the contact electrode is **inactive**.

3.4 Fault loop parameters



NOTE!

- If there are residual current devices in the network tested, they should be bypassed by bridging for the period of impedance measurement. However, it should be remembered that the tested circuit is modified in this way and the obtained results may slightly differ from the actual results.
- After completing measurements, always remove modifications introduced to the tested system for the period of measurements and check the operation of the residual current switch.
- The above remarks **do not apply** to measurements of fault loop impedance with the use of function **Z_{L-PE}[RCD]**.
- Measurements of short-circuit loop impedance **downstream the inverters** are **ineffective** and measurement results **unreliable**. This is due to the fluctuations of internal impedance of the inverter during its operations. Do not perform measurements of short-circuit loop impedance directly downstream inverters.

3.4.1 Settings of measurements

1



Select item **Z_{L-N, L-L}**, **Z_{L-PE}** or **Z_{L-PE}[RCD]**.

2

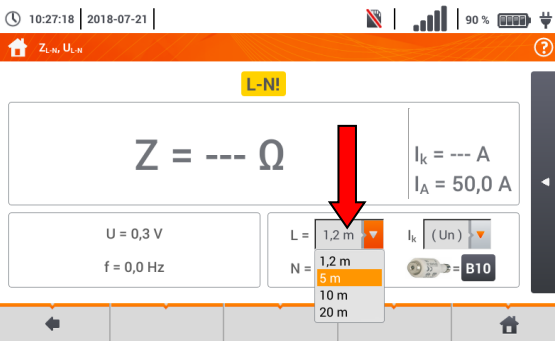

The correctness of the measurement depends on the correct adjustment of the length of leads.

If a **WS type adapter has not been connected** to the meter, standard manufacturer's lead lengths are available in the menu.

- In this case, touch the drop-down list field.
- Select the required lead length.

3

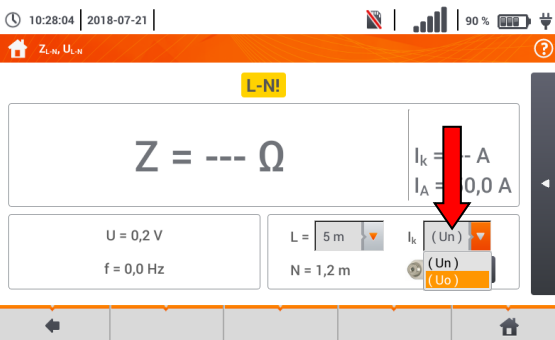

The prospective short-circuit current I_k can be calculated based on one of two values:

- ⇒ rated network voltage U_n ,
- ⇒ voltage measured by the meter U_0 .

The physical meaning of the parameter is presented in **section 3.4.5**.

- Touch the drop-down list field.
- Select the required value.

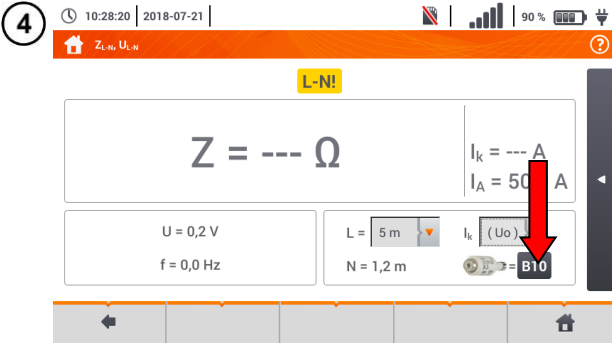

The result can be compared against the acceptable fault loop impedance Z_{sdop} , determined on the basis of the fuse parameters of the tested circuit:

- ⇒ characteristic,
- ⇒ rated current.

- Touch the fuse type field.

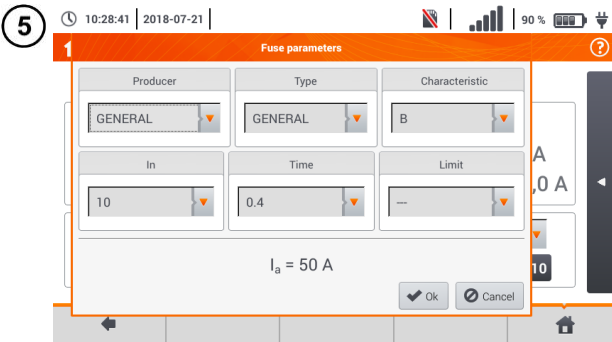

Options to select:

- **Manufacturer**
 - ⇒ GENERAL – no defined manufacturer
 - ⇒ manufacturers defined in the meter memory (**section 2.2.2**)
- **Type**
 - ⇒ GENERAL – no defined type
 - ⇒ types defined in the meter memory (**section 2.2.2**)
- **Time-current characteristic**
- **Rated current I_n**
- **Acceptable response time**
- **Limit** – the limit resulting from standard EN 60364-6
 - ⇒ --- – I_a as in the standard tables – no correction
 - ⇒ **2/3Z** – I_a is increased by the value of $0.5I_a$

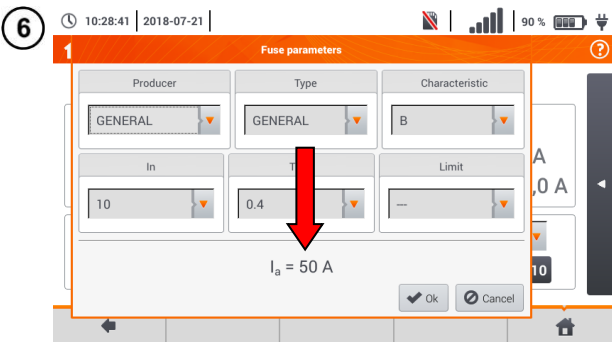

The current is calculated after setting parameters in steps (6) (7). I_a – current ensuring automatic triggering of a protective device within a required time.

Description of function icons

- Ok** – accept fuse settings
- Cancel** – cancel the action

3.4.2 Fault loop parameters in the L-N and L-L circuits

- 1 Connect test leads according to the drawing
 (a) or (b) for measurement in the L-N circuit,
 (c) for measurement in the L-L circuit.

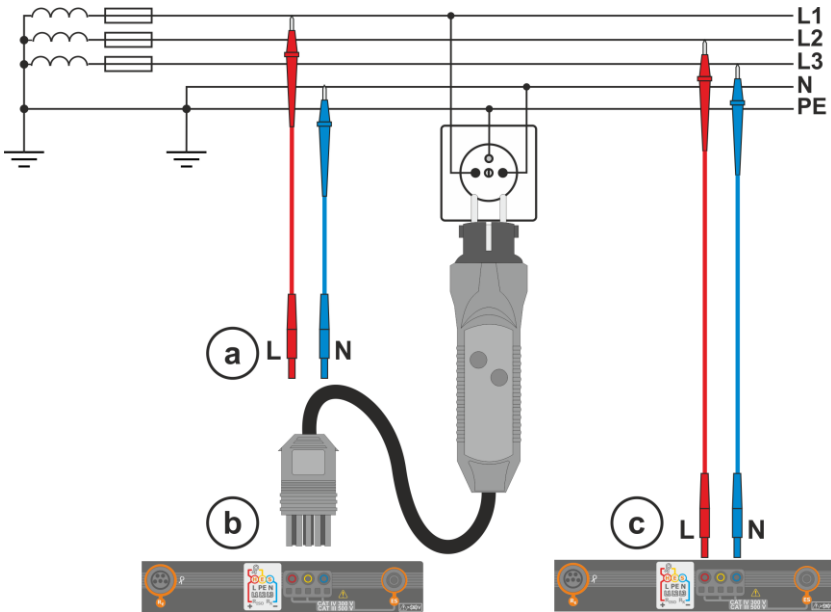

2



Select item $Z_{L-N, L-L}$.

3

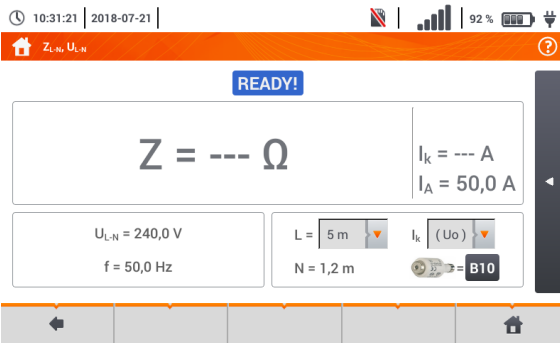

The measurement screen will appear.

Live mode

U_{L-N} – current voltage between phase and neutral conductors
 f – current frequency on the tested object

- 4 Enter the measurement settings in accordance with **section 3.4.1**.

5



Press **START** to perform measurement.

6

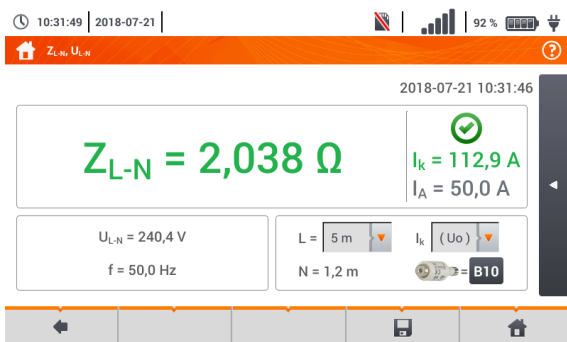

Read out the result.

Z_{L-N} – the main result
I_k – prospective short-circuit current with signalling the fulfilment of the acceptable loop criterion (**section 3.4.1**, step 6):

- met
- not met
- assessment not possible

I_A – current ensuring automatic triggering of a selected protective device within a required time

After selecting the bar on the right side, a menu will show with additional measurement results.

7

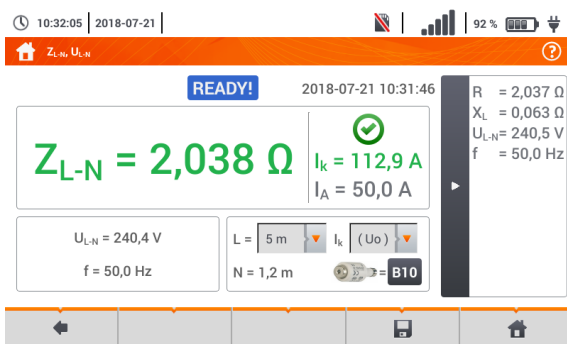

R – resistance of the tested circuit
X_L – reactance of the tested circuit
U_{L-N} – voltage relative to the neutral conductor
f – frequency

Selecting the bar hides the menu.

8

Save the measurement to the meter memory using the icon. A detailed description of memory management is contained in **section 5.3**.
 The last measurement can be recalled using the icon.



- When many measurements are performed in short time intervals, the meter may emit a large amount of heat. As a result of this, the housing of the device may become hot. This is **normal**. In addition, the meter is equipped with the protection against excessive temperature.
- After approx. 15 consecutive measurements of the fault loop wait until the instrument cools down. This limitation is due to the high current measurement and multifunctionality of the meter.
- Minimum **interval** between successive measurements is **5 seconds**. The displayed message **READY!** indicates that it is possible to perform another measurement. Until the message is displayed, the meter prevents any measurements.

Additional information displayed by the meter

READY!	The meter is ready for measurement.
IN PROGRESS	Measurement in progress.
L-N!	U_{L-N} voltage is incorrect for making a measurement.
L-PE!	U_{L-PE} voltage is incorrect for making a measurement.
N-PE!	U_{N-PE} voltage exceeds allowable value of 50 V.
L ↔ N	Phase connected to N terminal instead of L terminal (for example, exchange of L and N in the mains socket).
TEMPERATURE!	Maximum temperature inside the meter is exceeded.
f!	Network frequency is outside the range of 45...65 Hz.
ERROR!	Error during the measurement. Correct result cannot be displayed.
Loop circuit malfunction!	The meter should be serviced.
U>500V! and continuous audio signal	Before measurement, voltage at test terminals exceeds 500 V.
VOLTAGE!	The voltage on the tested object is not within the limits specified for the set rated voltage of the network U_n (section 2.2.1 step ①).
LIMIT!	Too low value of the prospective short circuit current I_k for the pre-set fuse and time of its triggering.

3.4.3 Fault loop parameters in the L-PE circuit

- 1 Connect test leads according to **Fig. 3.1** or **Fig. 3.2**.

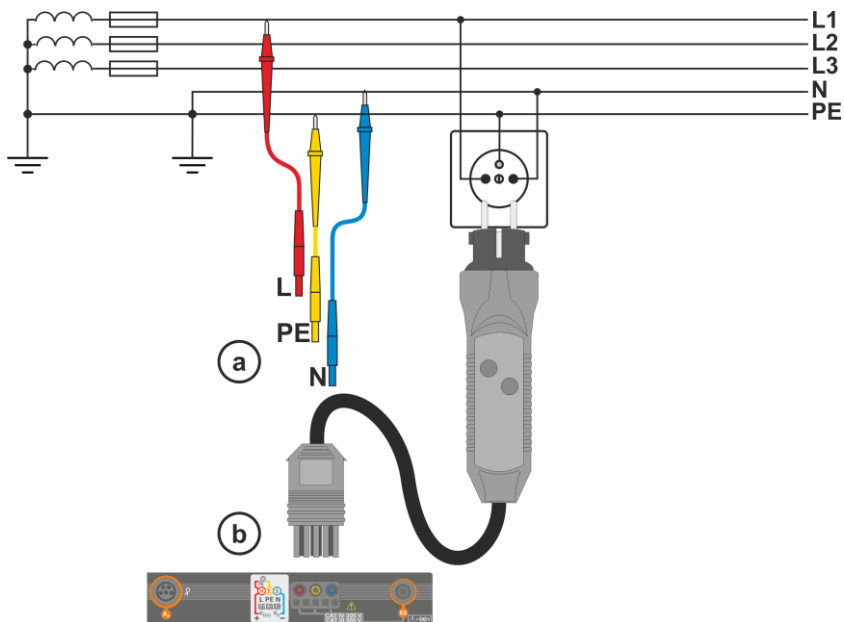

Fig. 3.1 Measurement in L-PE circuit

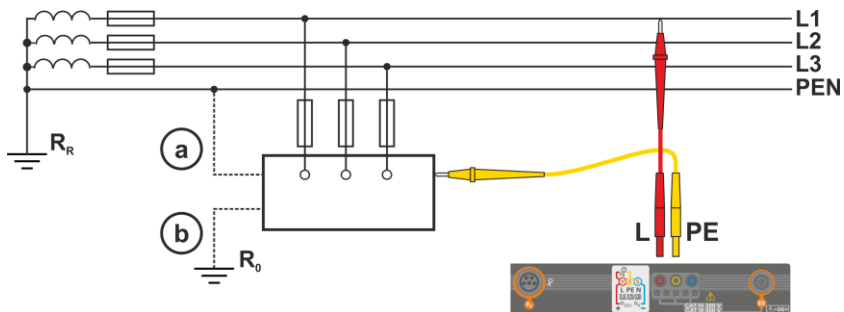

Fig. 3.2 Checking effectiveness of protection against electric shock of the meter housing in case of: **(a)** TN network or **(b)** TT network

- 2



Select item **ZL-PE**.

3 10:48:58 | 2018-07-21 | The measurement screen will appear.

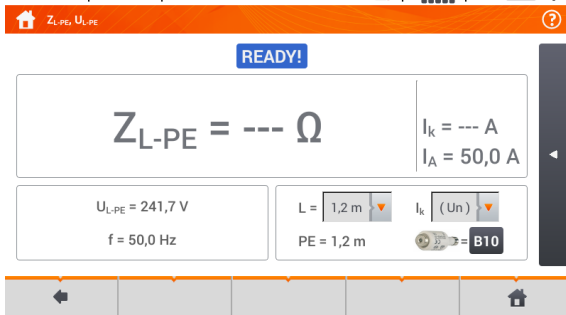

Live mode
U_{L-PE} – current voltage between phase and protective conductors
f – current frequency on the tested object

4 Enter the measurement settings in accordance with **section 3.4.1**.



Press the **START** button to perform measurement.

6 10:49:26 | 2018-07-21 | Read out the result.

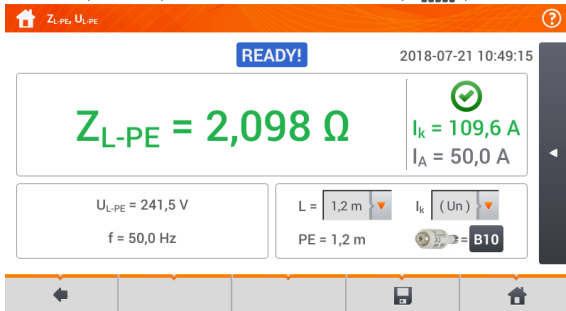

Z_{L-PE} – the main result
I_k – prospective short-circuit current with signalling the fulfilment of the acceptable loop **criterion** (**section 3.4.1**, step 6):
 met
 not met
 assessment not possible

I_a – current ensuring automatic triggering of a selected protective device within a required time

After selecting the bar on the right side, a menu will slide out with additional measurement results.

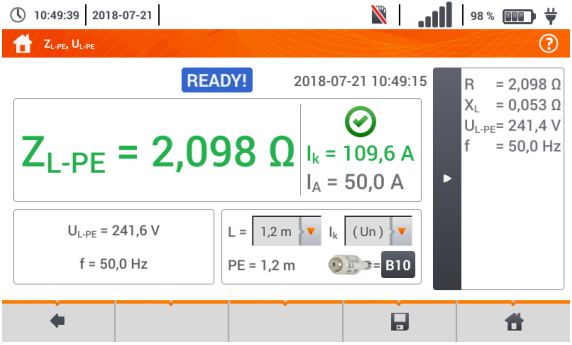

7



R – resistance of the tested circuit
 X_L – reactance of the tested circuit
 U_{L-PE} – voltage relative to the protective conductor
 f – frequency

Selecting the bar  hides the menu.

8

Save the measurement to the meter memory using the  icon. A detailed description of memory management is contained in **section 5.3**. The last measurement can be recalled using the  icon.



- Double-lead measurement is not available for the UNI-Schuko adapter.
- When many measurements are performed in short time intervals, the meter may emit a large amount of heat. As a result of this, the housing of the device may become hot. This is **normal**. In addition, the meter is equipped with the protection against excessive temperature.
- After approx. 15 consecutive measurements of the fault loop wait until the instrument cools down. This limitation is due to the high current measurement and multifunctionality of the meter.
- Minimum **interval** between successive measurements is **5 seconds**. The displayed message **READY!** indicates that it is possible to perform another measurement. Until the message is displayed, the meter prevents any measurements.

3.4.4 Fault loop impedance in L-PE circuit protected with a residual current device (RCD)

- 1 Connect test leads according to Fig. 3.3 , Fig. 3.4 lub Fig. 3.5.

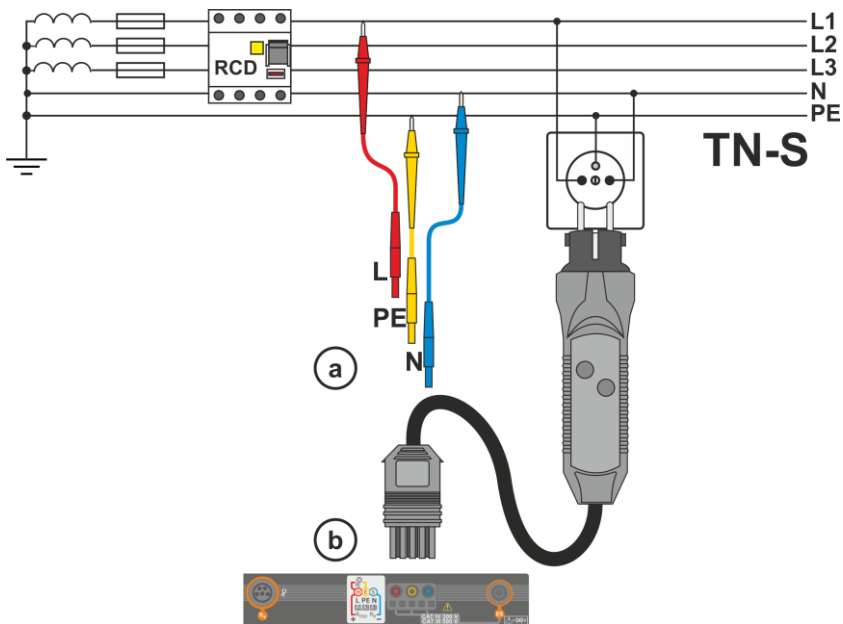

Fig. 3.3 Measurement in the TN-S system

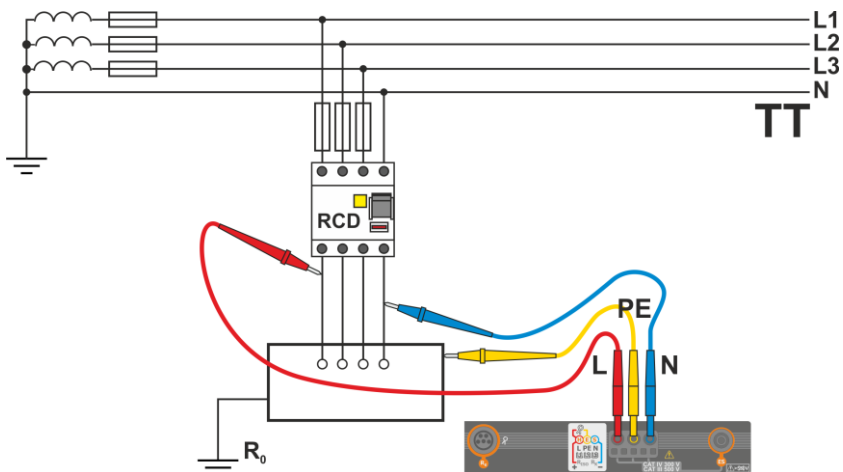

Fig. 3.4 Measurement in the TT system

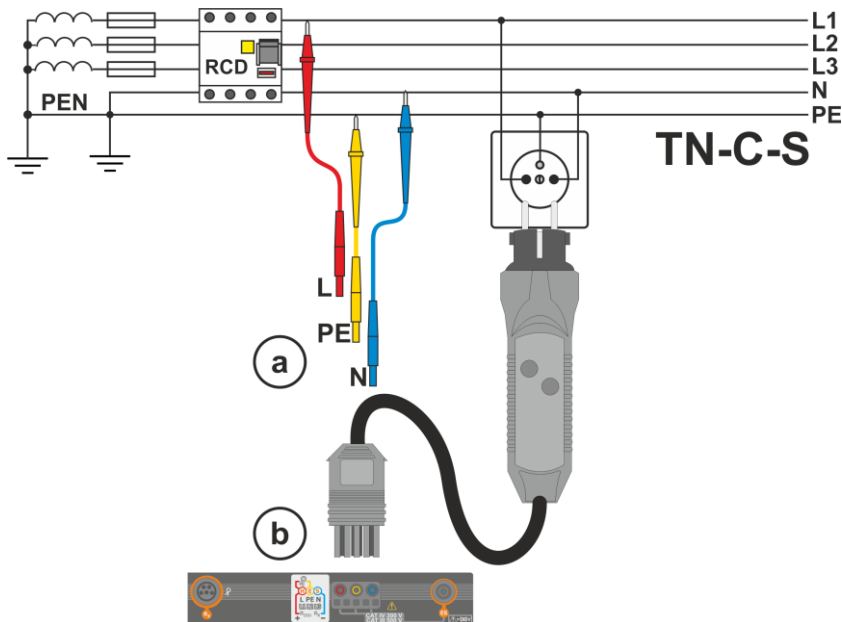

Fig. 3.5 Measurement in the TN-C-S system

2



Select item **Z_{L-PE}[RCD]**.

3

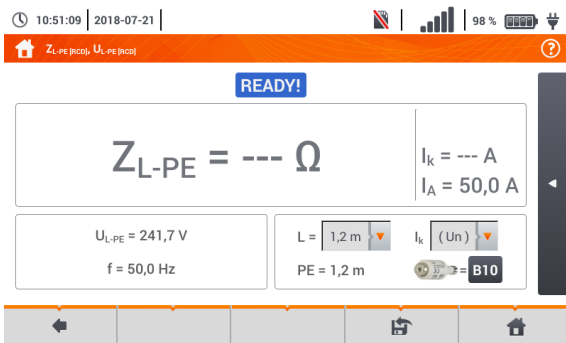

The measurement screen will appear.

Live mode

U_{L-PE} – current voltage between phase and protective conductors
f – current frequency on the tested object

4

Enter the measurement settings in accordance with **section 3.4.1**.

5



Press the **START** button to perform measurement.

6

10:51:55 | 2018-07-21



Read out the result.

Z_{L-PE} – the main result

I_k – prospective short-circuit current with signalling the fulfilment of the acceptable loop criterion (**section 3.4.1**, step 6):

- met
- not met
- assessment not possible

I_a – current ensuring automatic triggering of a selected protective device within a required time

After selecting the bar on the right side, a menu will slide out with additional measurement results.

7

10:52:10 | 2018-07-21

**R** – resistance of the tested circuit**X_L** – reactance of the tested circuit**U_{L-PE}** – voltage relative to the protective conductor**f** – frequency

Selecting the bar hides the menu.

8

Save the measurement to the meter memory using the icon. A detailed description of memory management is contained in **section 5.3**.

The last measurement can be recalled using the icon.



- Maximum measurement time is few seconds. The measurement can be interrupted by pressing the button.
- In the electrical installations with 30 mA RCD's, the sum of leakage currents of the installation and the test current may trigger the RCD. If this happens, try to reduce the leakage current in the tested mains (for example by disconnecting loads).
- The function works for residual current devices of rated current ≥ 30 mA.
- When many measurements are performed in short time intervals, the meter may emit a large amount of heat. As a result of this, the housing of the device may become hot. This is **normal**. In addition, the meter is equipped with the protection against excessive temperature.
- After approx. 15 consecutive measurements of the fault loop wait until the instrument cools down. This limitation is due to the high current measurement and multi-functionality of the meter.
- Minimum **interval** between successive measurements is **5 seconds**. The displayed message **READY!** indicates that it is possible to perform another measurement. Until the message is displayed, the meter prevents any measurements.

3.4.5 Prospective short-circuit current

The meter always measures fault loop impedance Z_s and the displayed short-circuit current is calculated according to the following formula:

$$I_k = \frac{U}{Z_s}$$

where:

Z_s – measured impedance,

U – voltage dependent on the network rated voltage settings U_n (section 3.4.1 point 4):

$I_k(U_n)$	$U = U_n$
$I_k(U_0)$	$U = U_0$ for $U_0 < U_n$
	$U = U_n$ for $U_0 \geq U_n$

where:

U_n – nominal voltage of the network,

U_0 – voltage measured by the meter.

On the basis of U_n rated voltage selected (section 2.2.1), the meter automatically recognizes the measurement at phase voltage or phase-to-phase voltage and takes it into account in the calculations.

If the voltage of the network being tested is outside the tolerance range, the meter will not be able to determine a proper rated voltage for the short-circuit current calculation. In such a case, --- will be displayed instead of short-circuit current value. Fig. 3.6 shows voltage ranges for which short-circuit current value is calculated.

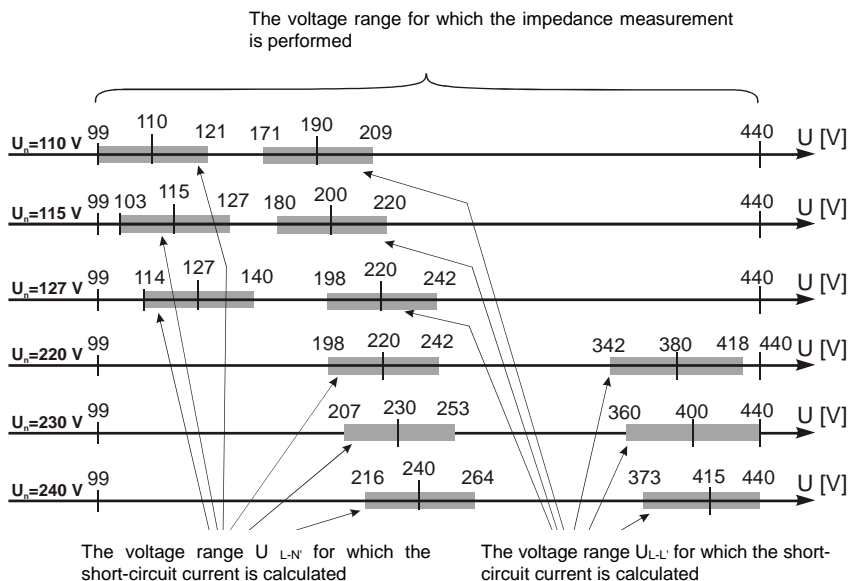

Fig. 3.6 Measuring voltage ranges

3.4.6 Measurement of fault loop impedance in IT networks

Before performing the measurements in the **Measurement settings** menu select the appropriate network type (**section 2.2.1**).



NOTE!

- After selecting an IT type network, the function of the contact electrode is **inactive**.
- When attempting to perform the **Z_{L-PE}** and **Z_{L-PE(RCD)}** measurement a message will appear informing that the measurement is impossible.

The manner of connecting the device to the installation is shown in **Fig. 3.7**.

The manner of performing the fault loop measurements is described in **section 3.4.2**.

Operating voltage range: **95 V ... 440 V**.

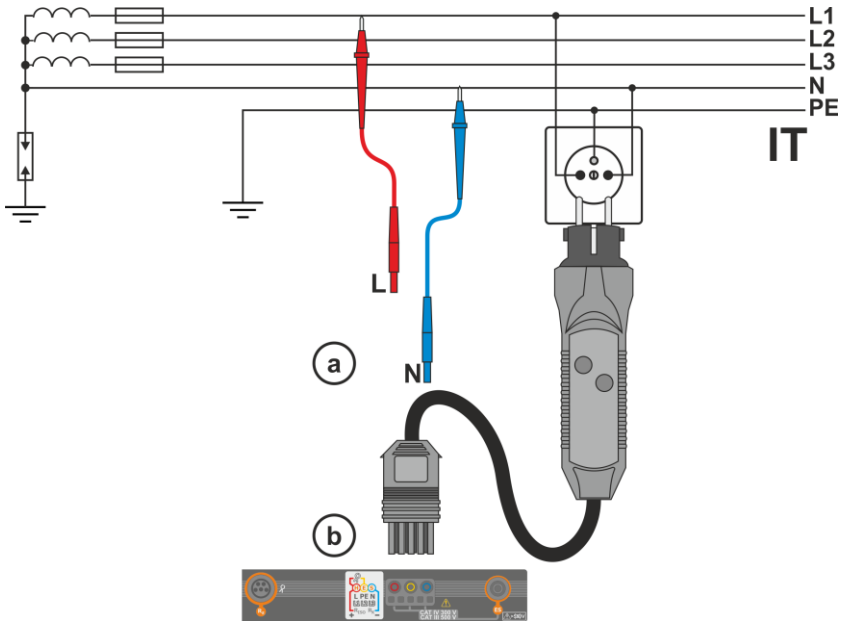
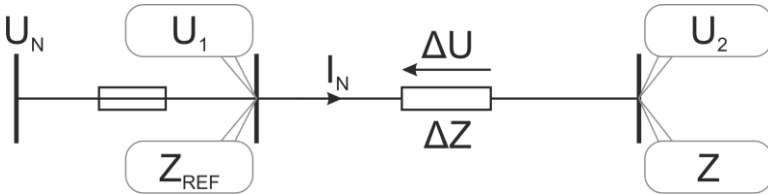

Fig. 3.7 Measurement in the IT system

3.5 Voltage drop

This function determines the voltage drop between two points of the tested network, selected by the user. The test is based on measurement of fault loop impedance L-N at these points. In a standard network, usually the voltage drop is tested between the socket and the switchgear (reference point).



The voltage drop is calculated according to the following formula:

$$\Delta U = \frac{(Z - Z_{REF}) \cdot I_N}{U_N} \cdot 100\%$$

where:

- Z – fault loop impedance at the destination point,
- Z_{REF} – fault loop impedance at the reference point,
- I_N – rated fuse current
- U_N – rated mains voltage.

①

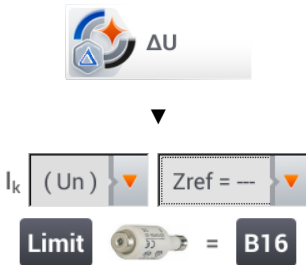

- Select item **ΔU**.
- Use setting **Zref=---** to reset previous measurement, if it has not been done yet.
- Enter the **limit** of voltage drop **ΔU_{MAX}**.
- Enter the **fuse type**, which protects the tested circuit.

②

- Connect the meter to the reference point of the tested network, as for Z_{L-N} measurement
- Press **START**.

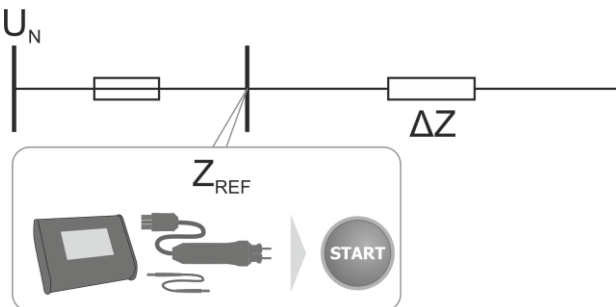

- 3 • Change the setting from **Zref** to **Z**.
- Connect the meter to the reference point, as for Z_{L-N} measurement.
- Press **START**.

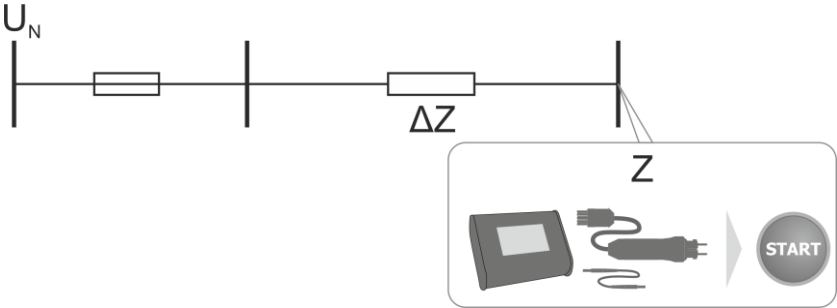

- 4 Read out the result.

READY! 2020-03-26 15:39:16

$\Delta U = 2,0\%$

$Z_{L-N,ref} = 0,383\ \Omega$ $Z_{L-N} = 0,677\ \Omega$ $I_k = 340\ A$ $\Delta U_{MAX} = 7,0\%$

$R = 0,667\ \Omega$
 $X_L = 0,112\ \Omega$
 $U_{L-N} = 229,5\ V$
 $f = 50,0\ Hz$
 $I_A = 80,0\ A$

L 215 V PE 1 V N
 229 V
 f = 50,0 Hz

I_k (L) Z Limit B16

ΔU – the main result and indication of meeting **criterion ΔU_{MAX}** :

- **green:** $\Delta U \leq \Delta U_{MAX}$
- **red:** $\Delta U > \Delta U_{MAX}$

I_k – prospective short-circuit current

After selecting the bar on the right side, a menu will slide out with additional measurement results.

- R – resistance of the tested circuit
- X_L – reactance of the tested circuit
- U_{L-N} – voltage relative to the neutral conductor
- f – frequency
- I_A – protection tripping current

Selecting the bar hides the menu.

- 5 Save the measurement to the meter memory using the icon. A detailed description of memory management is contained in **section 5.3**. The last measurement can be recalled using the icon.



If Z_{REF} is greater than Z , then the meter indicates $\Delta U = 0\%$

3.6 Resistance-to-earth

3.6.1 Settings of measurements

1



Select item **RE**.

2

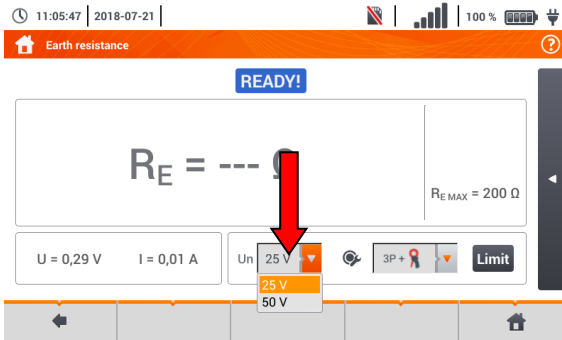

Touch the parameter drop-down menu **Un** (measuring voltage selection).

Select the required measuring voltage from the list.

3

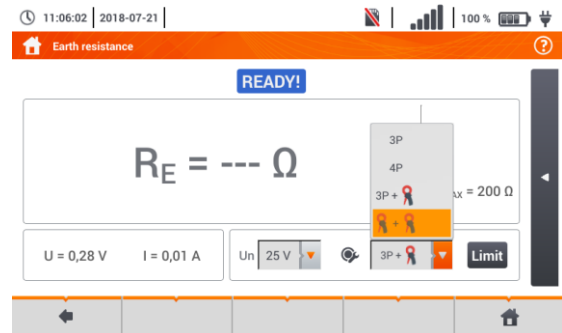

Touch the drop-down menu of measurement method selection.

Available measurement methods

- ⇒ 3-pole
- ⇒ 4-wire
- ⇒ 3-pole + receiving clamp
- ⇒ 2-clamp (transmitting + receiving clamp)

4



Select **Limit** to set the resistance limit.

- Select unit.
- Enter the required resistance limit value:
 - ⇒ 0.00...1990 for Ω ,
 - ⇒ 0.00...2 for $k\Omega$.

Functions of icons

- reject changes and exit to the previous screen
- accept changes

3.6.2 Earth resistance measurement with 3-pole method (R_E3P)

The three-pole measuring method is the basic type of resistance-to-earth measurement.

- 1 Disconnect the tested earth electrode from the installation of the facility.

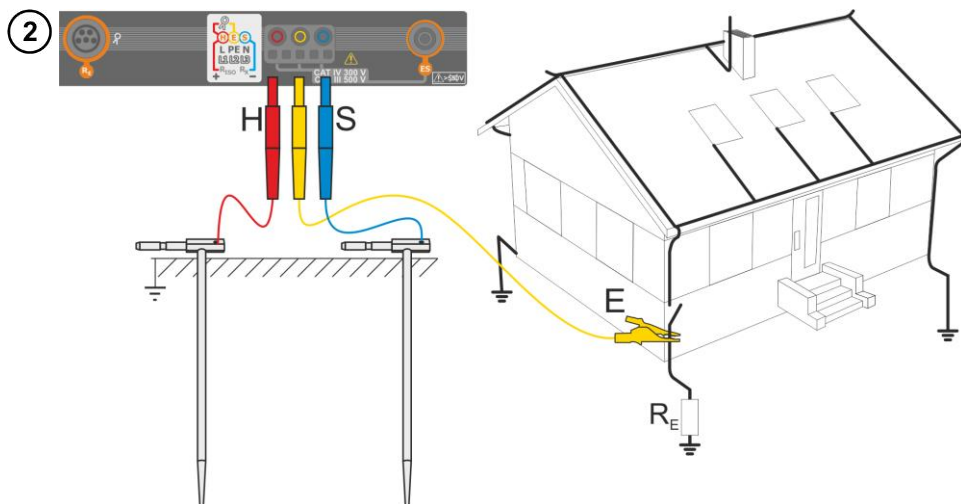
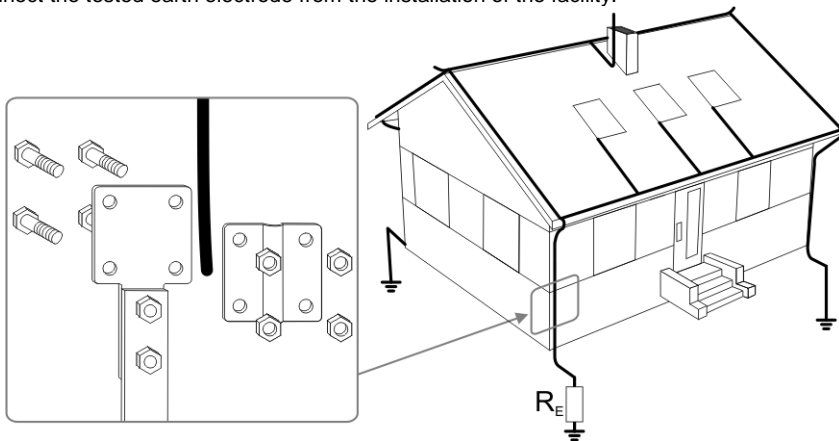

- Drive the **current** electrode into the earth and connect to the **H** socket of the meter.
- Drive the **voltage** electrode into the earth and connect to the **S** socket of the meter.
- The **earth electrode** being tested should be connected to **E** socket of the meter.
- It is recommended that the tested **earth electrode** as well as **H** and **S** electrodes should be located along one line and at relevant distances, in accordance with the rules of earth measurements.

3



- Select the **3P** option in the measurement menu.
- Select other settings in accordance with **section 3.6.1**.

4



The meter is ready for measurement.

- Live mode
U – interference voltage currently on the object
- Limits
R_E MAX – currently set earth resistance limit

5



Press **START** to start the measurement.

6

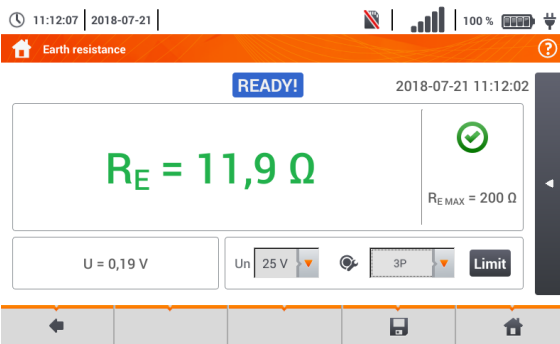

Read out the result.

- Signal lights for reaching the limit (section 3.6.1 step 6)
- ✔ the result is within the set limit
- ✘ the result is outside the set limit
- ⊖ assessment not possible

After selecting the bar ◀ on the right side, a menu will slide out with additional measurement results.

7

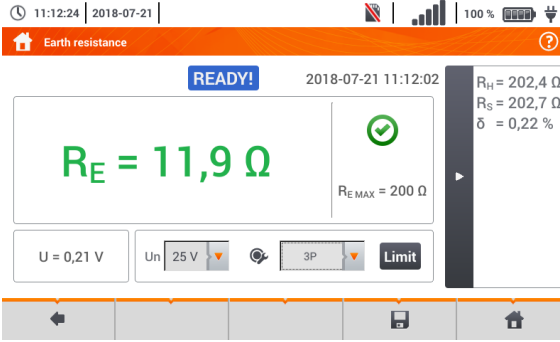

R_H – resistance of current electrode

R_S – resistance of voltage electrode

δ – additional uncertainty caused by resistance of the electrodes

Selecting the  bar hides the menu.

8

Save the measurement to the meter memory using the  icon. A detailed description of memory management is contained in **section 5.3**.

The last measurement can be recalled using the  icon.

9

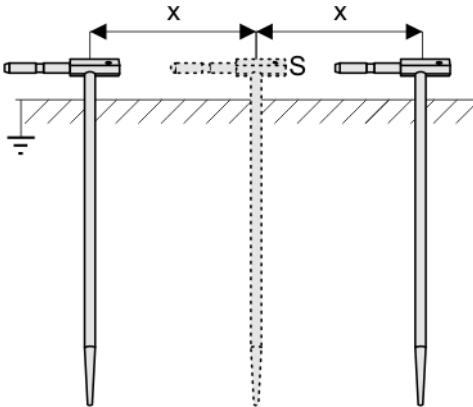

Repeat the steps [\(2\)](#) [\(5\)](#) [\(6\)](#) for two additional locations of the voltage electrode **S**:

- **located at a** certain distance from the tested earth electrode,
- **moved closer** by the same distance to the tested electrode.

This is done to confirm that the **S** electrode was driven into the reference earth. If so, **the difference between the value of R_E between the main measurement and each additional measurement should not exceed 3%**.

If R_E measurement results differ from one another by more than 3%, the distance of the current electrode from the earth electrode being tested **should be considerably increased** and the measurements should be repeated.



WARNING

- Measurement of resistance-to-earth may be carried out if voltage of interferences does not exceed 24 V. Voltage of interferences is measured up to the level of 100 V.
- Over 50 V it is signalled as hazardous. The meter must not be connected to voltages exceeding 100 V.



- It is recommended that the test **earth electrode** as well as **H** and **S** electrodes should be located in one line. Due to the different field conditions it is not always possible. On the website www.sonel.com and in professional literature special cases of probes location have been discussed.
- Particular attention should be paid to quality of connection between the object being tested and the test lead – the contact area must be free from paint, rust, etc.
- If **resistance of test probes is too high**, R_E earth electrode measurement will **include an additional uncertainty**. Particularly high uncertainty of measurement occurs when the tested resistance is small, and the probes have a weak contact with earth (such a situation occurs frequently when the earth electrode is well made but the upper soil layer is dry and slightly conductive). Then, the ratio of resistance of the probes to resistance of the tested earth electrode is very high and consequently, uncertainty of δ measurement that depends on this ratio is also very high.
- To reduce the uncertainty of the δ , measurement, the contact of the probe with earth may be improved, for example, by:
 - moistening the spot where the probe is driven with water,
 - driving the probe in a different location,
 - applying an 80 cm probe.Also, test the test leads for:
 - whether their insulation is not defective
 - whether the lead – banana plug – probe contact areas are not corroded or loosened.In majority of cases the achieved measurement accuracy is satisfactory. However, you should always take account of the uncertainty included in the measurement.

Additional information displayed by the meter

READY!	The meter is ready for measurement.
IN PROGRESS	Measurement in progress.
VOLTAGE!	Too high voltage at the meter terminals.
H!	Interruption in the test probe circuit.
S!	Interruption in the voltage probe circuit.
$R_E > 1.99 \text{ k}\Omega$	Measuring range is exceeded.
NOISE!	Signal / noise ratio is too low (interfering signal too large).
LIMIT!	Error due to the resistance of electrodes $> 30 \%$ (for calculating uncertainty, measured values are taken into account).
	Interruption in measuring circuit or resistance of test probes is higher than $60 \text{ k}\Omega$.

3.6.3 Earth resistance measurement with 4-wire method (R_{E4P})

Four-pole method is recommended for use in the measurement of earth resistance of very small values. It allows user to eliminate the influence of resistance of test leads on the measurement results. It is also suitable for determining the resistivity of the soil. However, it is recommended that the dedicated function should be used for this measurement (**section 3.7**).

① Disconnect the tested earth electrode from the installation of the facility.

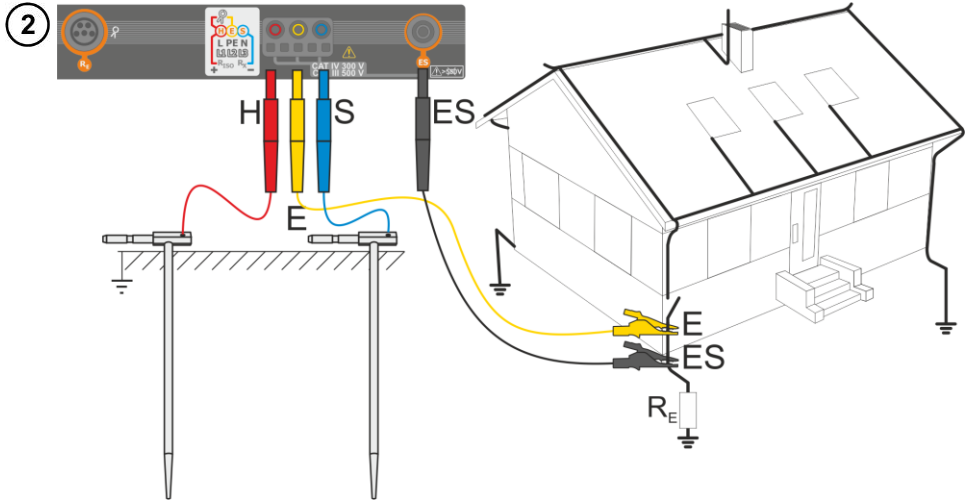
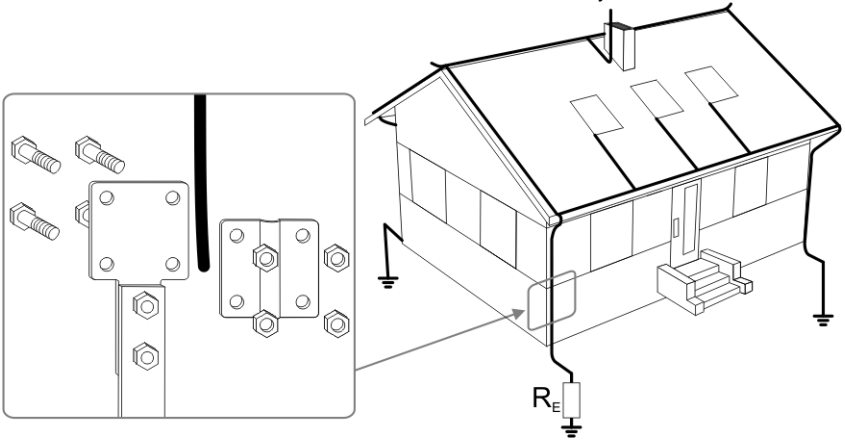

- Drive the **current** electrode into the earth and connect to the **H** socket of the meter.
- Drive the **voltage** electrode into the earth and connect to the **S** socket of the meter.
- The earth electrode being tested should be connected to **E** socket of the meter with the lead.
- **ES** socket should be connected to the tested earth electrode below **E** lead.

- It is recommended that the tested **earth electrode** as well as **H** and **S** electrodes should be located along one line and at relevant distances, in accordance with the rules of earth measurements.

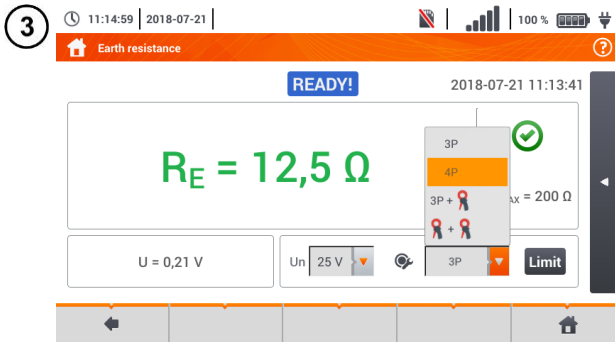

- Select the **4P** option in the measurement menu.
- Select other settings in accordance with **section 3.6.1**.

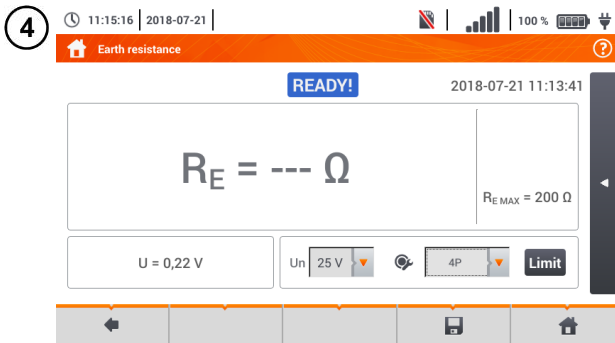

The meter is ready for measurement.

Live mode

U – interference voltage currently on the object

Limits

RE MAX – currently set earth resistance limit



Press **START** to start the measurement.

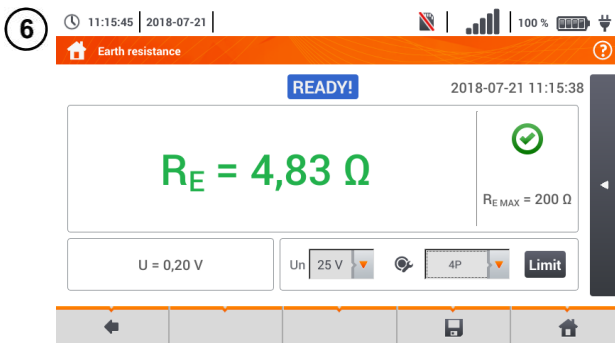

Read out the result.

Signal lights for reaching the limit (**section 3.6.1** step (6)):

- the result is within the set limit
- the result is outside the set limit
- assessment not possible

After selecting the bar on the right side, a menu will slide out with additional measurement results.

7

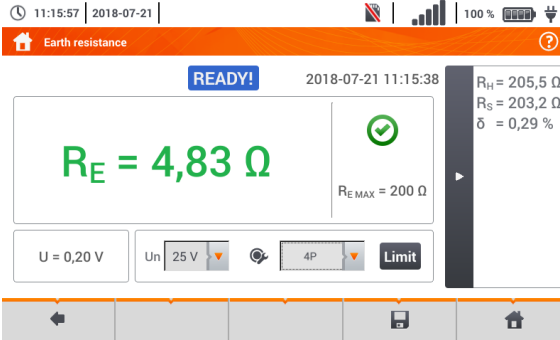

R_H – resistance of current electrode

R_S – resistance of voltage electrode

δ – additional uncertainty caused by resistance of the electrodes

Selecting the  bar hides the menu.

8

Save the measurement to the meter memory using the  icon. A detailed description of memory management is contained in **section 5.3**.

The last measurement can be recalled using the  icon.

9

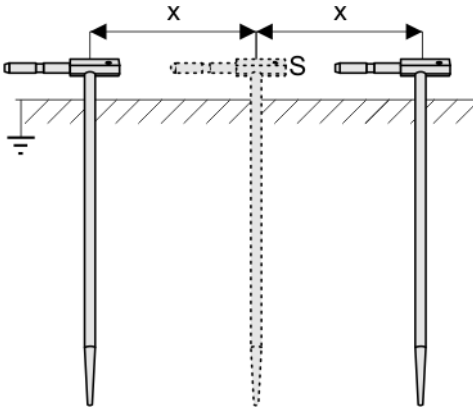

Repeat the steps [2](#) [5](#) [6](#) for two additional locations of the voltage electrode S:

- **at a certain distance** from the tested earth electrode,
- **moved closer** by the same distance to the tested earth electrode.

This is done to confirm that the **S** electrode was driven into the reference earth. If so, **the difference between the value of R_E between the main measurement and each additional measurement should not exceed 3%**.

If R_E measurement results differ from one another by more than 3%, the distance of the current electrode from the earth electrode being tested **should be considerably increased** and the measurements should be repeated.



WARNING

- Measurement of resistance-to-earth may be carried out if voltage of interferences does not exceed 24 V. Voltage of interferences is measured up to the level of 100 V.
- Over 50 V it is signalled as hazardous. The meter must not be connected to voltages exceeding 100 V.



- It is recommended that the test **earth electrode** as well as **H** and **S** electrodes should be located in one line. Due to the different field conditions it is not always possible. On the website www.sonel.com and in professional literature special cases of probes location have been discussed.
- - Particular attention should be paid to quality of connection between the object being tested and the test lead – the contact area must be free from paint, rust, etc.
- If **resistance of test probes is too high**, R_E earth electrode measurement will **include an additional uncertainty**. Particularly high uncertainty of measurement occurs when the tested resistance is small, and the probes have a weak contact with earth (such a situation occurs frequently when the earth electrode is well made but the upper soil layer is dry and slightly conductive). Then, the ratio of resistance of the probes to resistance of the tested earth electrode is very high and consequently, uncertainty of δ measurement that depends on this ratio is also very high. Then, in accordance with the formulas from **section 10.3.4**, calculations can be made to estimate the influence of measurement conditions.
- To reduce the uncertainty of the δ , measurement, the contact of the probe with earth may be improved, for example, by:
 - o moistening the spot where the probe is driven with water,
 - o driving the probe in a different location,
 - o applying an 80 cm probe.Also, test the test leads for:
 - o whether their insulation is not defective
 - o whether the lead – banana plug – probe contact areas are not corroded or loosened.In majority of cases the achieved measurement accuracy is satisfactory. However, you should always take account of the uncertainty included in the measurement.

Additional information displayed by the meter

READY!	The meter is ready for measurement.
IN PROGRESS	Measurement in progress.
VOLTAGE!	Too high voltage at the meter terminals.
H!	Interruption in the test probe circuit.
S!	Interruption in the voltage probe circuit.
RE>1.99 kΩ	Measuring range is exceeded.
NOISE!	Signal / noise ratio is too low (interfering signal too large).
LIMIT!	Error due to the resistance of electrodes > 30 % (for calculating uncertainty, measured values are taken into account).
	Interruption in measuring circuit or resistance of test probes is higher than 60 kΩ.

3.6.4 Earth resistance measurement with 3-pole method with additional clamp (R_{E3P+C})

1

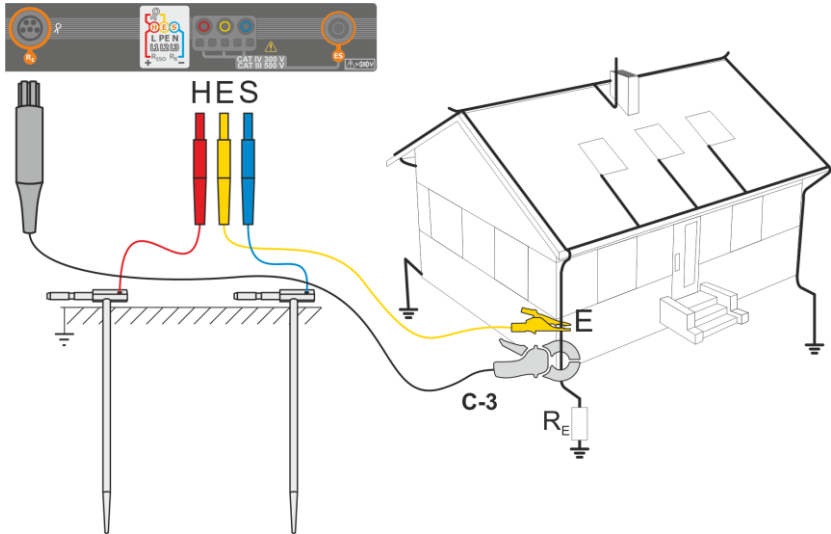

- Drive the **current** electrode into the earth and connect to the **H** socket of the meter.
- Drive the **voltage** electrode into the earth and connect to the **S** socket of the meter.
- The earth electrode being tested should be connected to the **E** socket of the meter with the lead.
- It is recommended that the tested **earth electrode** as well as **H** and **S** electrodes should be located along one line and at relevant distances, in accordance with the rules of earth measurements.
- **Receiving clamps** should be attached to the tested earth electrode below the connection point of **E** lead.
- **The arrow on the clamps** can be directed **in any direction**.

2



Select the **3P + clamps** option in the measurement menu.

Select other settings in accordance with **section 3.6.1**.

3 11:18:44 | 2018-07-21 | The meter is ready for measurement.

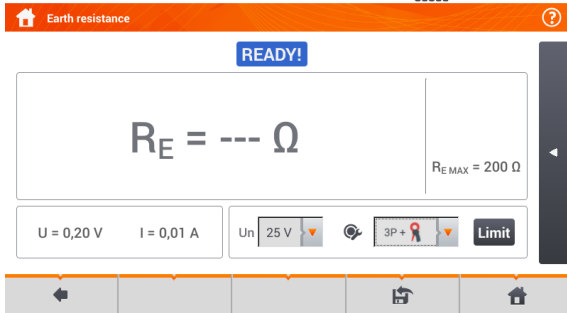

Live mode
U – interference voltage currently on the object
I – interference current currently flowing through the object

Limits
R_E MAX – currently set earth resistance limit



Press **START** to start the measurement.

5 11:19:08 | 2018-07-21 | Read out the result.

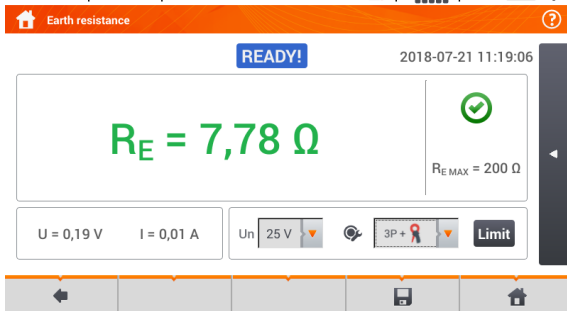

Signal lights for the limit (section 3.6.1 step (6))

- ✔ the result is within the set limit
- ✘ the result is outside the set limit
- ⊖ assessment not possible

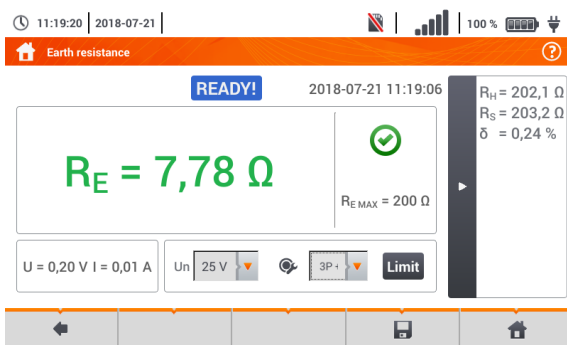

After selecting the bar ◀ on the right side, a menu will slide out with additional measurement results.

6 11:19:20 | 2018-07-21 |



R_H – resistance of current electrode
R_S – resistance of voltage electrode
δ – additional uncertainty caused by resistance of the electrodes

Selecting the ▶ bar hides the menu.

7 Save the measurement to the meter memory using the  icon. A detailed description of the memory management is contained in **section 5.3**. The last measurement can be recalled using the  icon.

8

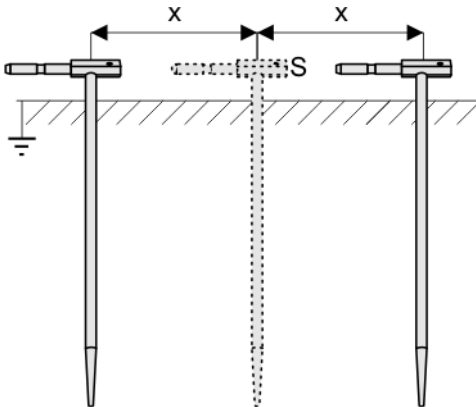

Repeat the steps (2)(5)(6) for two additional locations of the voltage electrode S:

- **located at a** certain distance from the tested earth electrode,
- **moved closer** by the same distance to the tested earth electrode.

This is done to confirm that the **S** electrode was driven into the reference earth. If so, **the difference between the value of R_E** between the main measurement and each additional measurement **should not exceed 3%**.

If R_E measurement results differ from one another by more than 3%, the distance of the current electrode from the earth electrode being tested **should be considerably increased** and the measurements should be repeated.



WARNING

- **Measurement of resistance-to-earth may be carried out if voltage of interferences does not exceed 24 V. Voltage of interferences is measured up to the level of 100 V.**
- **Over 50 V it is signalled as hazardous. The meter must not be connected to voltages exceeding 100 V.**



- It is recommended that the test **earth electrode** as well as **H** and **S** electrodes should be located in one line. Due to the different field conditions it is not always possible. On the website www.sonel.com and in professional literature special cases of probes location have been discussed.
- Use **C-3 clamps** for the measurement.
- Maximum interference current: 1 A.
- Particular attention should be paid to quality of connection between the object being tested and the test lead – the contact area must be free from paint, rust, etc.
- If **resistance of test probes is too high**, R_E earth electrode measurement will **include an additional uncertainty**. Particularly high uncertainty of measurement occurs when a small value of resistance-to-earth is measured with probes that have a weak contact with earth (such a situation occurs frequently when the earth electrode is well made and the upper soil layer is dry and slightly conductive). Then, the ratio of resistance of the probes to resistance of the tested earth electrode is very high and consequently, uncertainty of measurement that depends on this ratio is also very high. Then, in accordance with the formulas from **section 10.3.4**, calculations can be made to estimate the influence of measurement conditions. To reduce the uncertainty of the δ , measurement, the contact of the probe with earth may be im-

proved, for example, by:

- o moistening the spot where the probe is driven with water,
- o driving the probe in a different location,
- o applying an 80 cm probe.











Also, test the test leads for:

- o whether their insulation is not defective
- o whether the lead – banana plug – probe contact areas are not corroded or loosened.

In majority of cases the achieved measurement accuracy is satisfactory. However, you should always take account of the uncertainty included in the measurement.

- Factory calibration does not include the resistance of the test leads. The result displayed by the meter is a sum of the resistance of the measured object and the resistance of leads.

Additional information displayed by the meter

	The meter is ready for measurement.
	Measurement in progress.
	Too high voltage at the meter terminals.
	Measuring range is exceeded.
	Signal / noise ratio is too low (interfering signal too large).
	Error due to the resistance of electrodes > 30 % (for calculating uncertainty, measured values are taken into account).
	Interruption in measuring circuit or resistance of test probes is higher than 60 kΩ.
	Interruption in the test probe circuit.
	Interruption in the voltage probe circuit.
	Too small test current.
	No continuity in the current clamps circuit.

3.6.5 Earth resistance measurement with two-clamp method (2C)



- The double-clamp measurement may be applied where there is no possibility to use electrodes driven into the ground.
- The double-clamp method may only be used when measuring **multiple earthing** (it is necessary to provide a return path for the test current).
- For ring earth electrodes (step ① variant ②) the method allows **switching off to determine continuity** of the measured earth electrode point with the rest of the earth electrode.

① ②

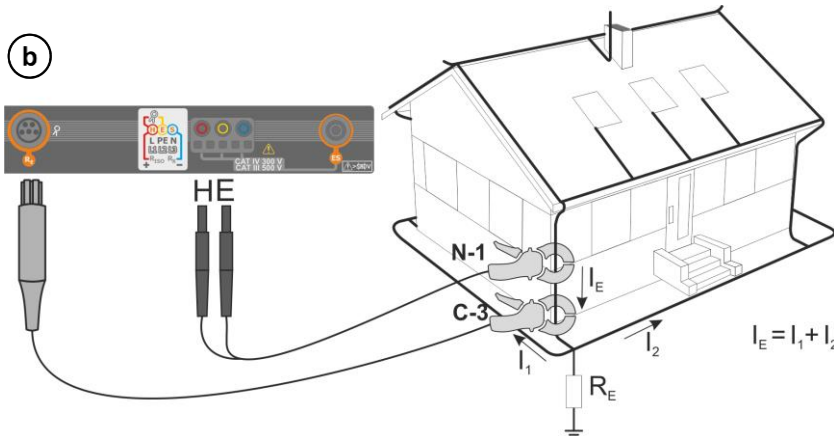
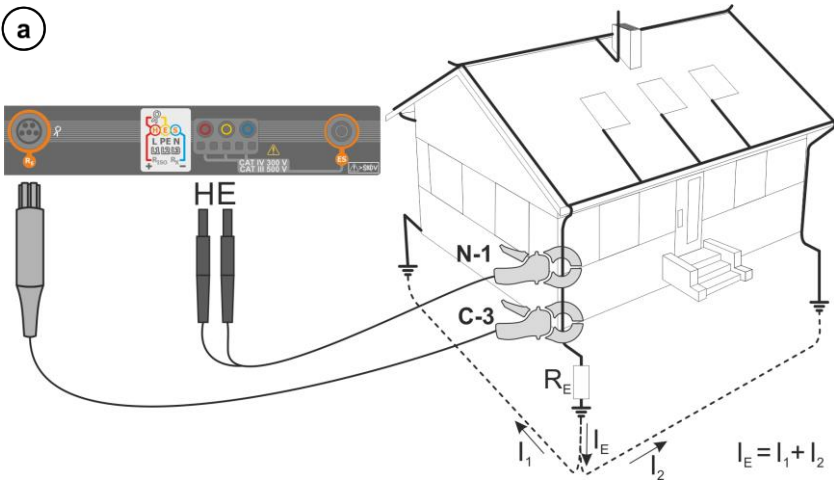

- Transmitting clamps and measuring clamps should be attached to the tested earth electrode **at a distance of at least 30 cm from each other**.
- **The arrow on the clamps can be directed in any direction.**
- Connect the transmitting **clamps N-1** to **H** and **E** socket.
- Connect the **measuring clamps C-3** to the clamp socket.

2



- Select the **clamps + clamps** option in the measurement menu.
- Select other settings in accordance with **section 3.6.1**.

3

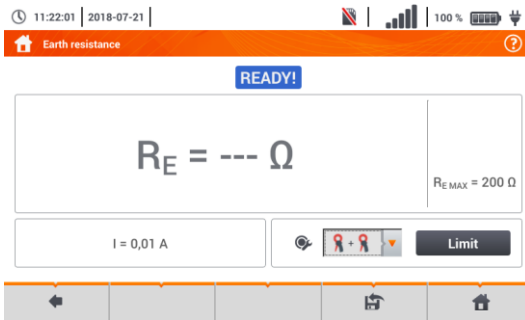

The meter is ready for measurement.

Live mode

I – interference current currently flowing through the object

Limits

R_E MAX – currently set earth resistance limit

4



Press **START** to start the measurement.

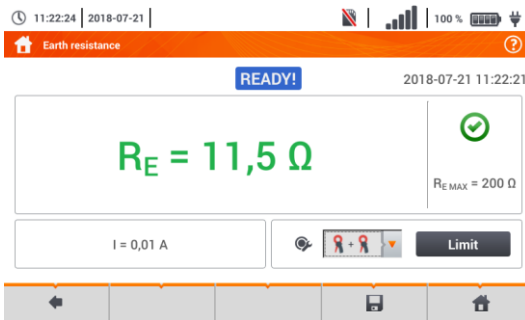



Read out the result.

Signal lights for the limit (section 3.6.1 step 6)

- ✓ the result is within the set limit
- ✗ the result is outside the set limit
- ⊖ assessment not possible







5

Save the measurement to the meter memory using the  icon. A detailed description of memory management is contained in **section 5.3**. The last measurement can be recalled using the  icon.



- Measurements may be performed in the presence of interference current of a value not exceeding 3 A RMS and frequency in accordance with the value set in sub-menu **Measurement settings (section 2.2.1 step ①)**.
- Use **N-1 clamps** as signal transmitting clamps and **C-3 clamps** as receiving clamps.
- If the current on measuring clamps is too low, the meter displays the following message: **The current measured by clamps is too low. Measurement is not possible!**
- Maximum interference current: 1 A.

Additional information displayed by the meter

	The meter is ready for measurement.
	Measurement in progress.
	Measuring range is exceeded.
	Signal / noise ratio is too low (interfering signal too large).
	Error due to the resistance of electrodes > 30 % (for calculating uncertainty, measured values are taken into account).
	Too small test current.
	No continuity in the current clamps circuit.

3.7 Soil resistivity

For soil resistivity measurements – used as preparation for the designing the earthing system or in geology measurements – a separate function is provided: measurement of soil resistivity ρ . This function is identical to 4-wire measurement of earth resistance, however, it contains an additional procedure of entering the distance between the electrodes. The measurement result is the resistivity value, calculated automatically according to the formula applied in Wenner method:

$$\rho = 2\pi LR_E$$

where:

L – distance between the electrodes (all distances must be equal),

R_E – measured resistance.

3.7.1 Settings of measurements

1



Select item **Ωm**.

2

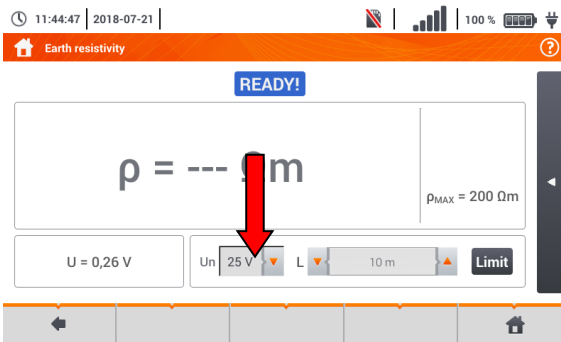

Touch the parameter drop-down menu **Un** (measuring voltage selection).

3



Select the required measuring voltage from the list.

4

11:44:47 | 2018-07-21



Select **Limit** to set the soil resistivity limit.

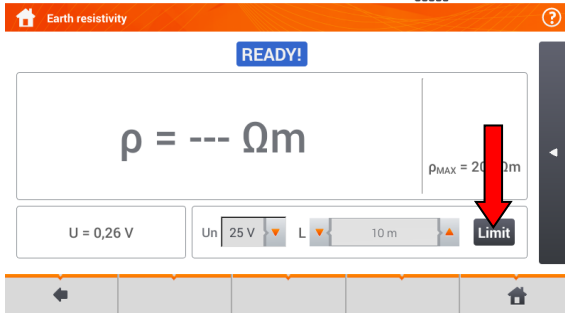

5

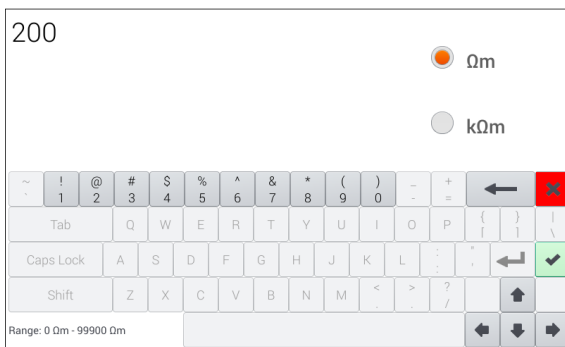

- Select unit.
- Enter the required resistance limit value:
 ⇒ **Ωm**: 0...99 900,
 ⇒ **kΩm**: 0...100.

Functions of icons

- reject changes and exit to the previous screen
- accept changes

3.7.2 Main elements of the screen

1



Select item **Soil resistivity Ωm**.

2

11:44:47 | 2018-07-21



The measurement screen will appear.

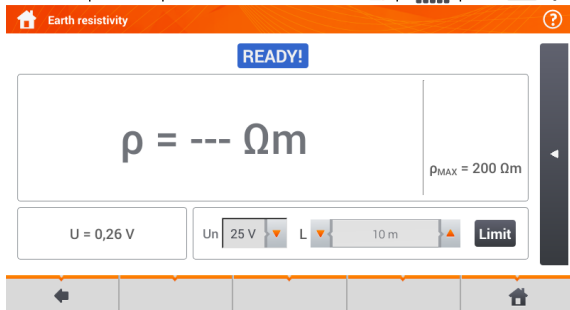

Live mode

U – interference voltage

Limits

ρMAX – soil resistivity limit

After selecting the bar on the right side, a menu will slide out with additional measurement results.

3

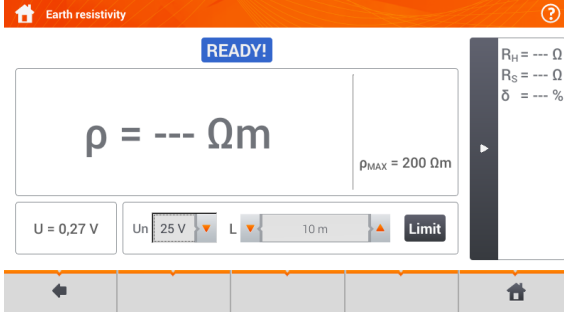

R_H – resistance of current electrode
 R_S – resistance of voltage electrode
 δ – additional uncertainty caused by resistance of the electrodes

Selecting the bar hides the menu.

3.7.3 Soil resistivity measurements (ρ)

1

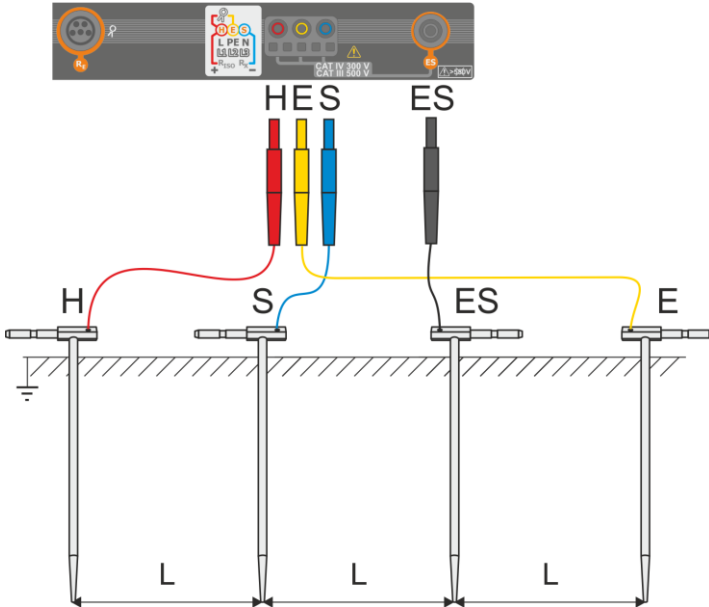

- Drive 4 probes into the ground **in one line** and at **equal** distances.
- Connect the probes to the meter according to the figure above.

2

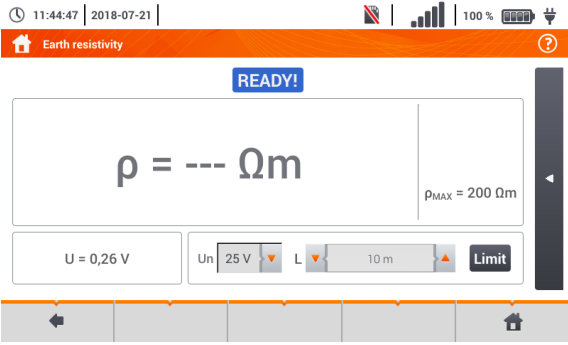

- Call up the measurement menu.
- Select other settings in accordance with **section 3.7.1**.

3



Select distance **L** between the measuring electrodes:

a

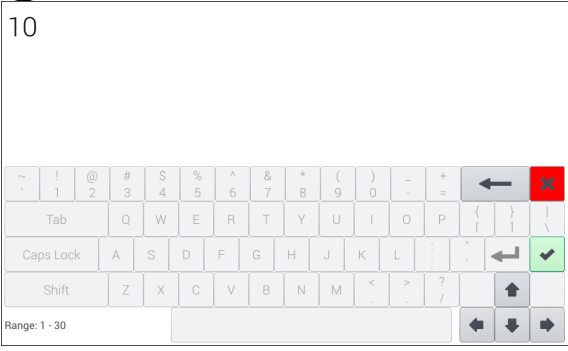

- a) using arrows ,
- b) from the keyboard after touching the field with the distance value (range 1...30 m)

Functions of icons

- reject changes and exit to the previous screen
- accept changes

4

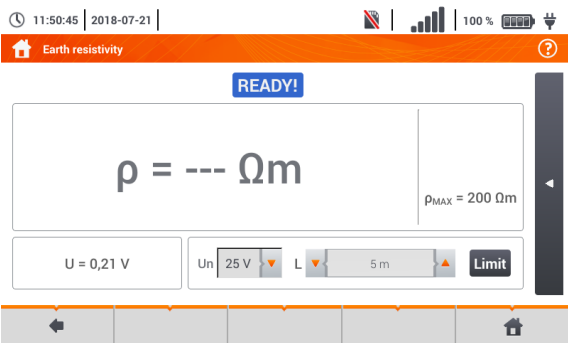

The meter is ready for measurement.

5



Press **START** to start the measurement.

6

11:51:55 | 2018-07-21 |



Read out the result.

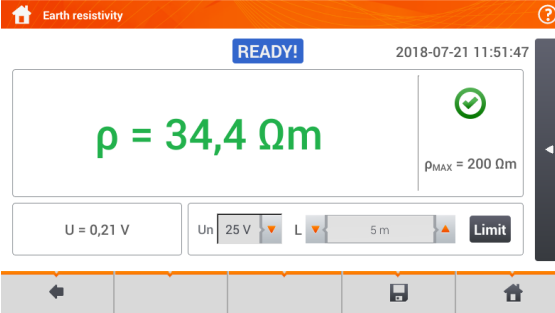

Signal lights for reaching the limit (section 3.7.1 step 4):

- the result is within the set limit
- the result is outside the set limit
- assessment not possible

After selecting the bar on the right side, a menu will slide out with additional measurement results.

7

11:52:07 | 2018-07-21 |

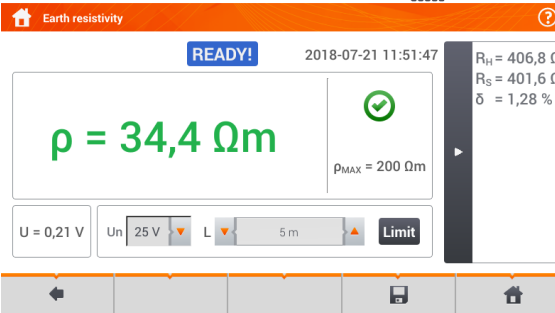
 R_H – resistance of current electrode R_S – resistance of voltage electrode δ – additional uncertainty caused by resistance of the electrodes

Selecting the bar hides the menu.

8

Save the measurement to the meter memory using the icon. A detailed description of memory management is contained in section 5.3.

The last measurement can be recalled using the icon.

**WARNING**

- Measurement of resistivity may be carried out if voltage of interferences does not exceed 24 V. Voltage of interferences is measured up to the level of 100 V.
- Over 50 V it is signalled as hazardous. The meter must not be connected to voltages exceeding 100 V.



- The calculations assume that the distance between the measuring electrodes are equal (Wenner method). If it is not the case, perform the measurement of earth resistance using 4-pole method and calculate resistivity from the formula:

$$\rho = 2\pi LR_E$$

where:

L – distance between the electrodes

R_E – measured resistance

- Particular attention should be paid to quality of connection between the object being tested and the test lead – the contact area must be free from paint, rust, etc.
- If **resistance of test probes is too high**, resistivity measurement **will include an additional uncertainty**. A particularly large measurement uncertainty arises when a small resistance value is measured with probes that have weak contact with the ground. Then, the ratio of resistance of the probes to measured resistance as a resistivity formula component is very high and consequently, uncertainty of measurement that depends on this ratio is also very high. Then, in accordance with the formulas from **section 10.3.4**, calculations can be made to estimate the influence of measurement conditions.
- To reduce the uncertainty of the $\bar{\delta}$, measurement, the contact of the probe with earth may be improved, for example, by:
 - o moistening the spot where the probe is driven with water,
 - o driving the probe in a different location,
 - o applying an 80 cm probe.Also, test the test leads for:
 - o whether their insulation is not defective
 - o whether the lead – banana plug – probe contact areas are not corroded or loosened.

In majority of cases the achieved measurement accuracy is satisfactory. However, you should always take account of the uncertainty included in the measurement.

Additional information displayed by the meter

READY!	The meter is ready for measurement.
IN PROGRESS	Measurement in progress.
VOLTAGE!	Too high voltage at the meter terminals.
H!	Interruption in the test probe circuit.
S!	Interruption in the voltage probe circuit.
RE>1.99 kΩ	Measuring range is exceeded.
NOISE!	Signal / noise ratio is too low (interfering signal too large).
LIMIT!	Error due to the resistance of electrodes > 30 % (for calculating uncertainty, measured values are taken into account).
	Interruption in measuring circuit or resistance of test probes is higher than 60 kΩ.

3.8 RCD parameters



The measurement of U_B , R_E is always performed with sinusoidal current $0.4 I_{\Delta n}$ regardless of the settings concerning waveform and multiplication factor $I_{\Delta n}$.

3.8.1 Settings of measurements

1



Select item **RCD I_A** or **RCD t_A** .

2

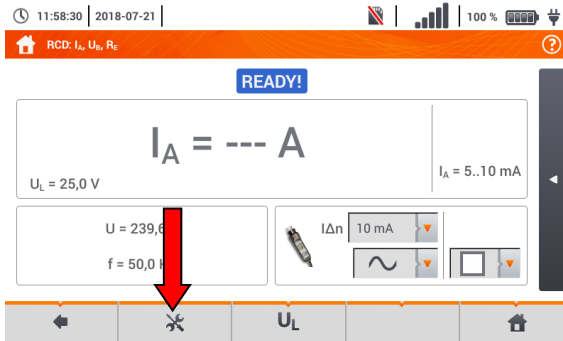

Define the displayed measurement components with the  icon:

- a) if **RCD I_A** has been selected,
- b) if **RCD t_A** has been selected.

3a

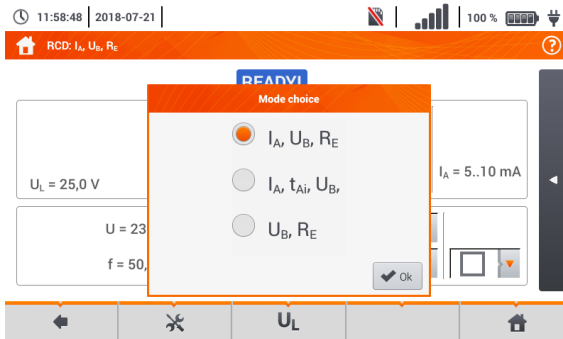

For **RCD I_A** the following parameters are available:
 I_A – RCD tripping current,
 U_B – voltage measured on PE,
 R_E – PE continuity,
 t_{Ai} – RCD triggering time when measuring tripping current.

3b

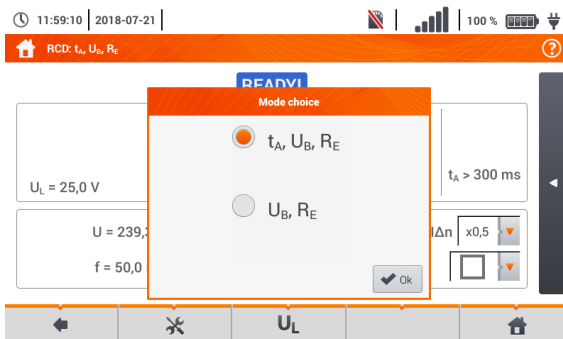

For **RCD t_A** the following parameters are available:
 U_B – voltage measured on PE,
 R_E – PE continuity,
 t_A – RCD triggering time when given the rated differential current ratio.

4

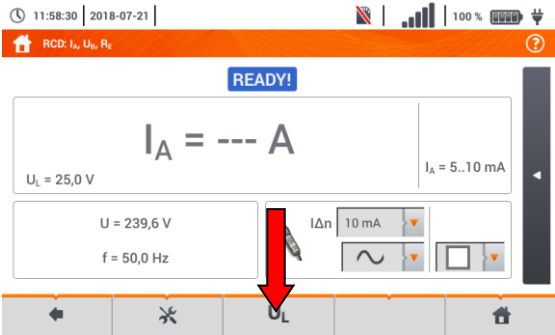

Select U_L to define the measuring voltage.

5

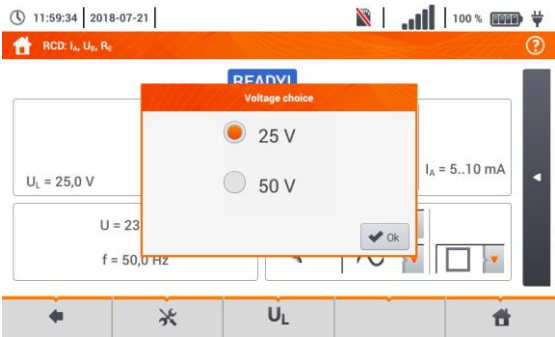

Select the required measuring voltage from the list.

6

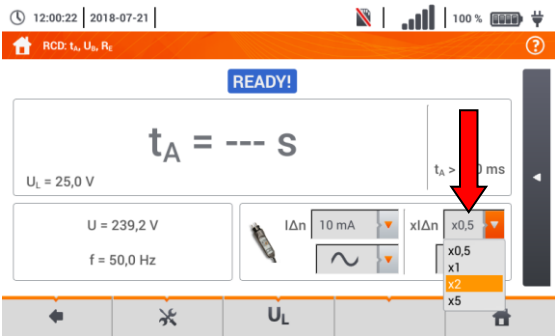

If the RCD t_A mode has been selected in step ①, set the forced current in the RCD test.

The set current is ratio of the rated residual current of the tested circuit breaker.

7

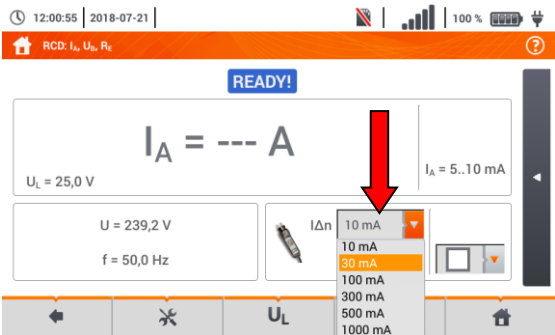

The correctness of the assessment of the test circuit breaker efficiency is dependent on the rated residual current.

Rated differential currents of RCDs are available in the menu.

- Touch the drop-down list field.
- Select the residual current of the test circuit breaker.

8

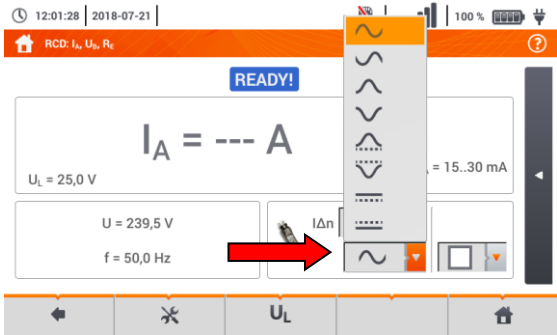

In the menu you can the waveform of the current, which will be used to test the RCD.

- Touch the drop-down list field. Select the waveform of the measuring current.

9

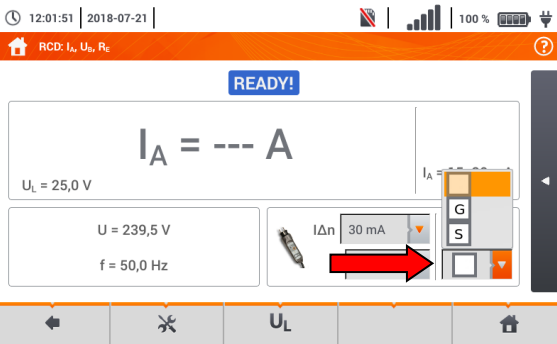

Determine the type of circuit breaker.

Available circuit breaker types

- general purpose
- G short-time delay type
- S selective

3.8.2 RCD tripping current

- 1 Connect the meter to the installation according to the drawing.

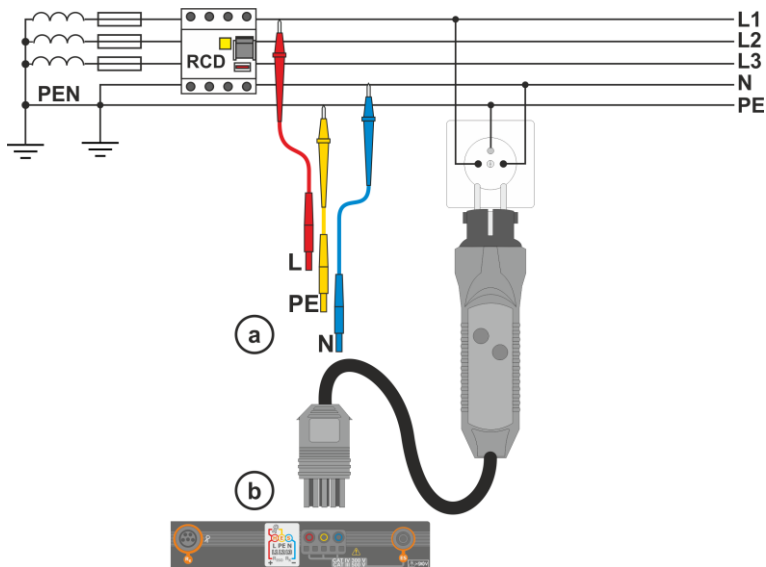

- 2



Select item **RCD I_A**.

- 3 Enter the measurement settings in accordance with **section 3.8.1**.

- 4

12:01:12 | 2018-07-21 | 100% The meter is ready for measurement.

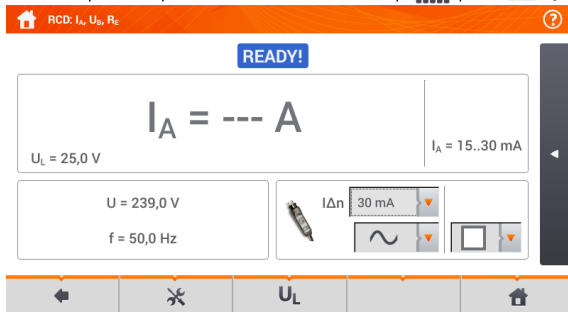

Live mode

U – voltage between phase conductor L and PE conductor
f – network frequency in the tested circuit

- 5



Press **START** to start the measurement.

To cancel measurement, select the  icon on the screen.

6

Read out the result.

Measurement result assessment

green:

$$0.5 I_{\Delta n} < I_A \leq I_{\Delta n}$$

red:

$$I_A \leq 0.5 I_{\Delta n} \\ \text{or} \\ I_A > I_{\Delta n}$$

After selecting the bar  on the right side, a menu will slide out with additional measurement results.

7

Depending on the selection made in section 3.8.1 step ② some of the parameters below will be displayed:



UB – voltage measured on PE,

RE – PE continuity,

tA – RCD triggering time with flow of RCD disconnecting current.

Selecting the  bar hides the menu.

8

Save the measurement to the meter memory using the  icon. A detailed description of memory management is contained in **section 5.3**. The last measurement can be recalled using the  icon.



- Measurement of the triggering time t_{Ai} (t_A measured during I_A measurement) for **selective RCDs is not available**.
- The measurement of triggering time t_{Ai} **is not performed as required** by applicable standards (i.e **with RCD nominal** current $I_{\Delta n}$), but **with I_A** current measured and displayed during the measurement. In most cases where the measurement does not have to be strictly as defined by the standard, this measurement may be taken into account to assess the proper operation of RCD protection in a particular installation. When measured I_A is lower than $I_{\Delta n}$ (most frequent case), then triggering time t_{Ai} will be usually longer than the triggering time measured in function t_A , which measures the time at $I_{\Delta n}$ current:

$$I_A < I_{\Delta n} \Rightarrow t_{Ai} > t_A$$

where:

$$t_{Ai} = f(I_{\Delta n})$$

Therefore, when time t_{Ai} is correct (not too long), it may be assumed that the time measured in function t_A would be also correct (it would not be longer).

Additional information displayed by the meter

IN PROGRESS	Measurement in progress.
U_B>U_L!	The touch voltage exceeds a preset U _L threshold value.
READY!	The meter is ready for measurement.
L-N!	U _{L-N} voltage is incorrect for making a measurement.
L-PE!	U _{L-PE} voltage is incorrect for making a measurement.
N-PE!	U _{N-PE} voltage is incorrect for making a measurement.
L ↔ N	Phase connected to N terminal instead of L terminal (for example, exchange of L and N in the mains socket).
f!	Network frequency is outside the range of 45...65 Hz.
PE!	PE conductor connected incorrectly.
ERROR!	Measurement error.
U>500V!	Before measurement, voltage at test terminals exceeds 500 V.

3.8.3 RCD tripping time

1 Connect the meter to the installation according to the drawing.

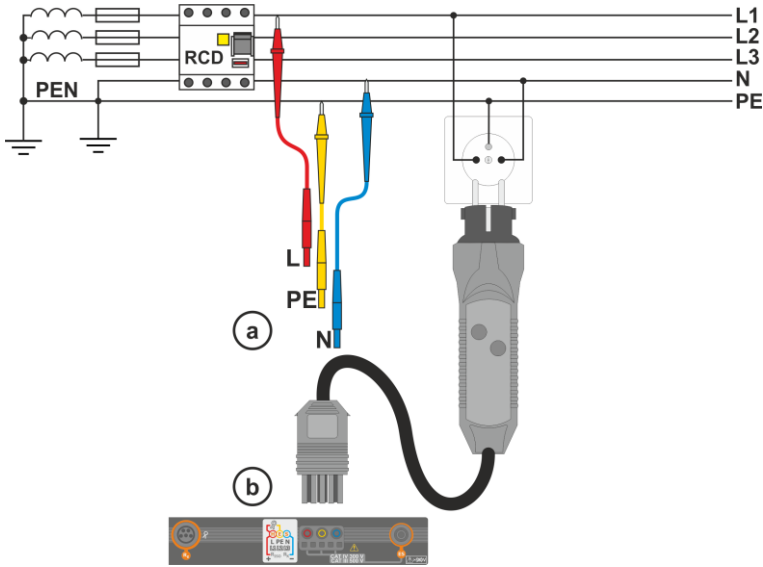

2



Select item **RCD t_A** .

3 Enter the measurement settings in accordance with **section 3.8.1**.

4

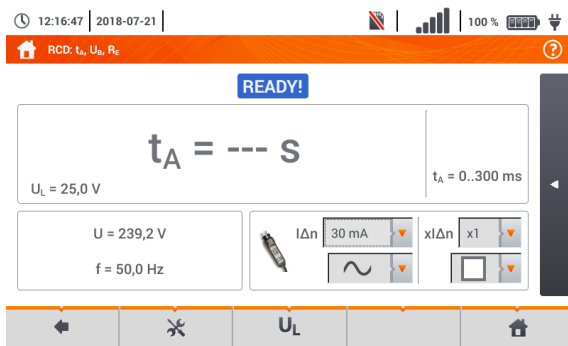

The meter is ready for measurement.

Live mode

U – voltage between phase conductor L and PE conductor
f – network frequency in the tested circuit

5



Press **START** to start the measurement.

6

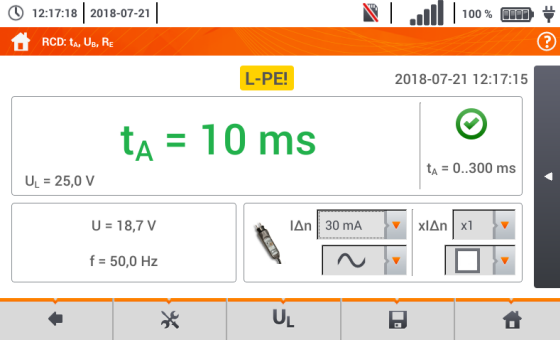

Read the result – RCD triggering time t_A .

Measurement result assessment

green:

$$t_A \leq t_{dop}$$

red:

$$t_A > t_{dop}$$

After selecting the bar  on the right side, a menu will slide out with additional measurement results.

7

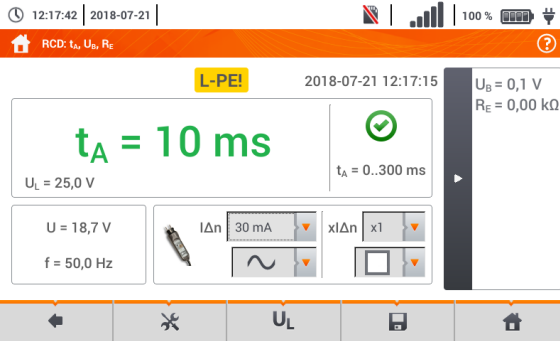



Depending on the selection made in section 3.8.1 step 2 some of the parameters below will be displayed:

U_B – voltage measured on PE,
 R_E – PE continuity.

Selecting the  bar hides the menu.

8

Save the measurement to the meter memory using the  icon. A detailed description of memory management is contained in section 5.3.

The last measurement can be recalled using the  icon.

Additional information displayed by the meter

IN PROGRESS	Measurement in progress.
$U_B > U_L!$	The touch voltage exceeds a preset U_L threshold value.
No U_{L-N}!	Lack of neutral lead that is necessary for $I_{\Delta N}$ constant and pulsed with direct current offset
READY!	The meter is ready for measurement.
L-N!	U_{L-N} voltage is incorrect for making a measurement.
L-PE!	U_{L-PE} voltage is incorrect for making a measurement.
N-PE!	U_{N-PE} voltage is incorrect for making a measurement.
L ↔ N	Phase connected to N terminal instead of L terminal (for example, exchange of L and N in the mains socket).
TEMPERATURE!	Maximum temperature of the meter is exceeded.
f!	Network frequency is outside the range of 45...65 Hz.
PE!	PE conductor connected incorrectly.
ERROR!	Measurement error.
$U > 500V!$	Before measurement, voltage at test terminals exceeds 500 V.
VOLTAGE!	Voltage exceeded.

3.8.4 Measurements in IT networks

Before performing measurements select the appropriate network type in the main menu (menu **Measurement settings**, section 2.2.1).



NOTE!

After selecting an IT type network, the function of the **contact electrode** is inactive.

The manner of connecting the device to the installation is shown in **Fig. 3.8** and **Fig. 3.9**.

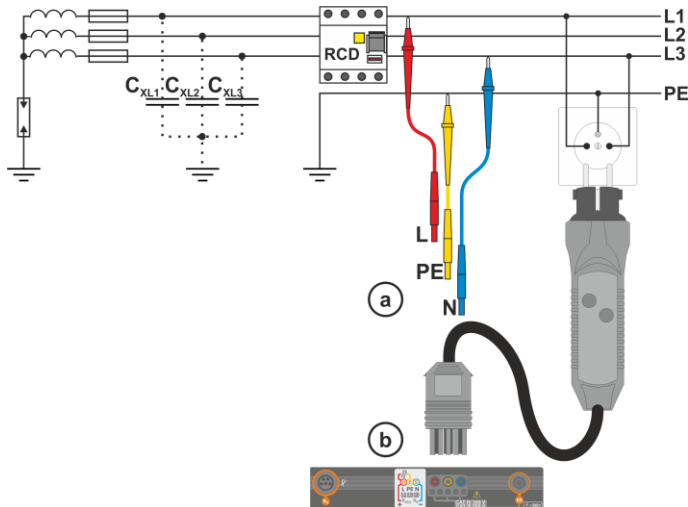

Fig. 3.8 RCD measurement in the IT network. The circuit is closed by the parasitic capacitances C_x

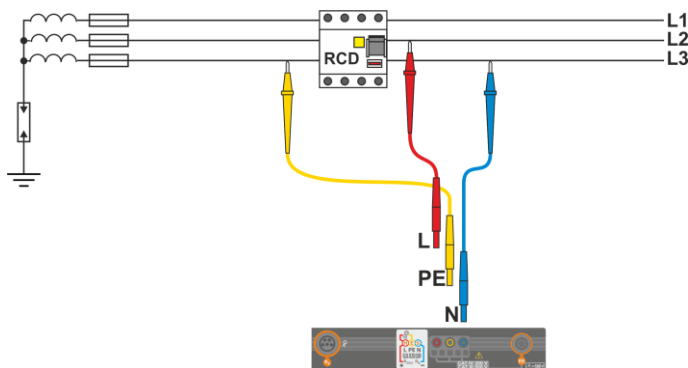

Fig. 3.9 RCD testing without the PE conductor

The manner in which the measurements of current and the RCD triggering time has been described in **section 3.8.2 ,3.8.3**.

Operating voltage range: **95 V ... 270 V**.

3.9 Automatic measurements of RCD parameters

The meter enables user to measure automatically RCD triggering time (t_A), disconnection current (I_A), contact voltage (U_B) and resistance-to-earth (R_E). In this mode, there is no need to trigger each measurement by pressing **START** button. The role of the user is reduced to initiating the measurement by single pressing **START** and switching RCD on after each tripping.

3.9.1 Setting automatic measurements of RCD parameters

①  Select **RCD_{AUTO}**.

②  • Select **U_L** and from then select the required measuring voltage from the list.

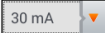
$I_{\Delta n}$  • Select the rated differential current of tested protection.

 • Select the type of tested protection.

③  • Select the parameters to be measured. Designations:
I_A tripping current
t_A response time
+ current with increasing head is forced
- current with decreasing head is forced
x0.5 / 1 / 2 / 5 a multiplicity of RCD rated current, according to IEC 61557-6

• Select the metering mode:

- Ⓐ full,
- Ⓑ standard.

④a  If **full** mode has been selected, select the type of tested protection.

 **RCD other than EV.** There is no 6 mA DC module in this type of device.

 **EV type RCD.** Here there is a 6 mA DC module. In this situation, before the test it is necessary to:

- determine according to which standard the measurement is to be carried out (**sec. 2.2.1**),
- determine the multiplication factor of the 6 mA DC differential current (**EV** button). The test settings vary depending on the selected standard.

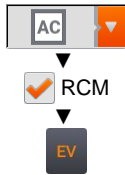

RCD other than the EV, which is protected by a RCM (residual current monitoring device at 6 mA DC). In this situation, before the test it is necessary to:

- determine according to which standard the measurement is to be carried out (**sec. 2.2.1**),
- tick **RCM**,
- determine the multiplication factor of the 6 mA DC differential current (**EV** button). The test settings vary depending on the selected standard.

4b



If **standard** mode has been selected, set the shape of the testing current. In this mode, RCD EV and RCM tests are unavailable.

3.9.2 Automatic measurement of RCDs

1 Connect the meter to the installation according to the drawing.

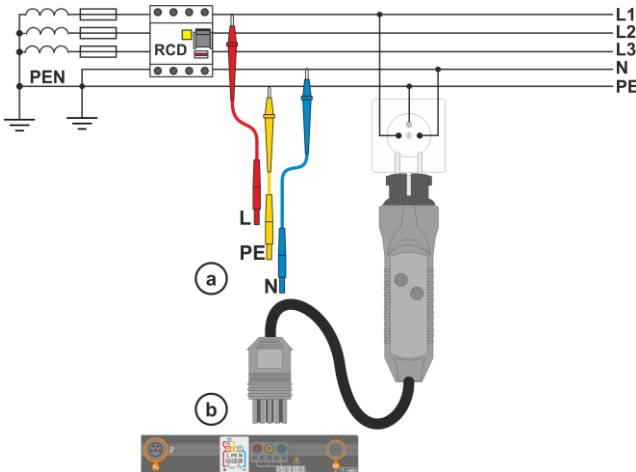

2



Select **RCD_{AUTO}**.

3

Enter the measurement settings in accordance with **section 3.9.1**.

4

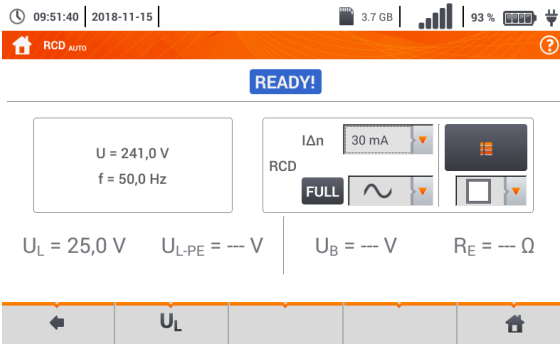

The meter is ready for measurement.

Live mode

U – voltage between phase conductor L and PE conductor
f – network frequency in the tested circuit

5



Press **START** to start the measurement.

6

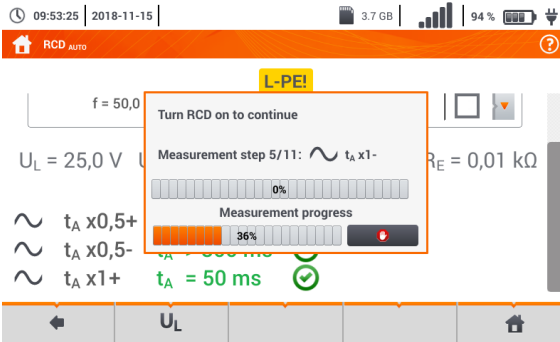

Tested RCD switch, must be **turned on** after each triggering, measurements are **completed**.

The progress of the measurement is illustrated by progress bars:
top – progress of the ongoing measurement,
bottom – progress of the entire measurement sequence.

The sequence may be cancelled at any time using icon .

7

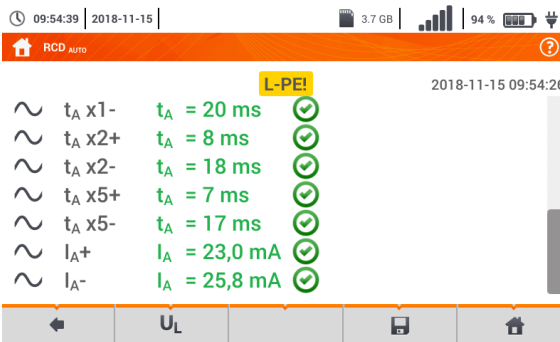



Eventually, measured parameters are displayed (**sec. 3.9.1** step **5**), and:

UL – test voltage,
UL-PE – voltage between L and PE,
UB – voltage measured on PE,
RE – PE continuity.



The list of results may be scrolled on the screen.

Symbols indicating correctness of response

-  criterion met
-  criterion not met

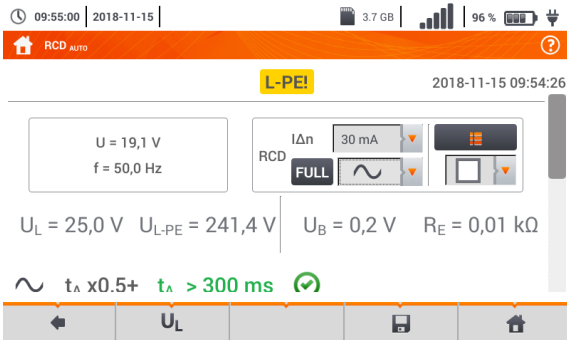
For more information refer to **Criteria for assessing the correctness of component results**.



- 8 Save the measurement to the meter memory using the  icon. A detailed description of memory management is contained in **section 5.3**. The last measurement can be recalled using the  icon.



- U_B and R_E are always measured.
- The measurement of U_B, R_E is always performed with sinusoidal current 0.4 I_{Δn} regardless of the settings concerning waveform and multiplication factor I_{Δn}.
- Automatic measurement is interrupted in the following cases:
 - the switch was tripped during the measurement of U_B, R_E or t_A at the half value of I_{Δn},
 - the switch did not trip during other component measurements,
 - the value of pre-set voltage U_L has been exceeded,
 - voltage was disconnected during one of the component measurements,
 - values R_E and mains voltage did not allow to generate the required current value for one of component measurements.
- The meter automatically skips the measurements impossible to perform, e.g. when the value of selected current I_{Δn} and its multiplicity exceed the testing range of the meter.

Criteria for assessing the correctness of component results

Parameter	Assessment criterion	Notes
$I_A \sim$	$0.5 I_{\Delta n} \leq I_A \leq 1 I_{\Delta n}$	-
$I_A \wedge \wedge$ $I_A \Delta \Delta$	$0.35 I_{\Delta n} \leq I_A \leq 2 I_{\Delta n}$	for $I_{\Delta n} = 10 \text{ mA}$
$I_A \wedge \wedge$ $I_A \Delta \Delta$	$0.35 I_{\Delta n} \leq I_A \leq 1.4 I_{\Delta n}$	for other $I_{\Delta n}$
$I_A \dots$	$0.5 I_{\Delta n} \leq I_A \leq 2 I_{\Delta n}$	-
$I_A \dots 6 \text{ mA}$	$3 \text{ mA} \leq I_A \leq 6 \text{ mA}$	for 6 mA RCD EV and RCM (acc. to IEC 62955 and IEC 62752)
t_A at $0.5 I_{\Delta n}$	$t_A \rightarrow \text{rcd}$	<ul style="list-style-type: none"> ▪ for all types of RCD ▪ for AC module of RCD EV
t_A at $1 I_{\Delta n}$	$t_A \leq 300 \text{ ms}$	<ul style="list-style-type: none"> ▪ for general purpose RCDs □ ▪ for AC module of RCD EV
t_A at $2 I_{\Delta n}$	$t_A \leq 150 \text{ ms}$	<ul style="list-style-type: none"> ▪ for general purpose RCDs □ ▪ for AC module of RCD EV
t_A at $5 I_{\Delta n}$	$t_A \leq 40 \text{ ms}$	<ul style="list-style-type: none"> ▪ for general purpose RCDs □ ▪ for AC module of RCD EV
t_A at $1 I_{\Delta n}$	$130 \text{ ms} \leq t_A \leq 500 \text{ ms}$	for selective RCDs S
t_A at $2 I_{\Delta n}$	$60 \text{ ms} \leq t_A \leq 200 \text{ ms}$	for selective RCDs S
t_A at $5 I_{\Delta n}$	$50 \text{ ms} \leq t_A \leq 150 \text{ ms}$	for selective RCDs S
t_A at $1 I_{\Delta n}$	$10 \text{ ms} \leq t_A \leq 300 \text{ ms}$	for short-time delay RCDs G
t_A at $2 I_{\Delta n}$	$10 \text{ ms} \leq t_A \leq 150 \text{ ms}$	for short-time delay RCDs G
t_A at $5 I_{\Delta n}$	$10 \text{ ms} \leq t_A \leq 40 \text{ ms}$	for short-time delay RCDs G
t_A at $1 I_{\Delta n}$	$t_A \leq 10 \text{ s}$	for 6 mA RCD EV and RCM ($I_{\Delta} = 6 \text{ mA}$ acc. to IEC 62955 and IEC 62752)
t_A at $10 I_{\Delta n}$	$t_A \leq 300 \text{ ms}$	for 6 mA RCD EV and RCM ($I_{\Delta} = 60 \text{ mA}$ acc. to IEC 62955 and IEC 62752)
t_A at $33 I_{\Delta n}$	$t_A \leq 100 \text{ ms}$	for 6 mA RCD EV and RCM ($I_{\Delta} = 200 \text{ mA}$ acc. to IEC 62955)
t_A at $50 I_{\Delta n}$	$t_A \leq 40 \text{ ms}$	for 6 mA RCD EV and RCM ($I_{\Delta} = 300 \text{ mA}$ acc. to IEC 62752)

Additional information displayed by the meter

IN PROGRESS	Measurement in progress.
U_B>U_L!	The touch voltage exceeds a preset U _L threshold value.
No U_{L-N}!	Lack of neutral lead that is necessary for I _{Δn} constant and pulsed with direct current offset
READY!	The meter is ready for measurement.
L-N!	U _{L-N} voltage is incorrect for making a measurement.
L-PE!	U _{L-PE} voltage is incorrect for making a measurement.
N-PE!	U _{N-PE} voltage is incorrect for making a measurement.
L ↔ N	Phase connected to N terminal instead of L terminal (for example, exchange of L and N in the mains socket).
TEMPERATURE!	Maximum temperature of the meter is exceeded.
f!	Network frequency is outside the range of 45...65 Hz.
PE!	PE conductor connected incorrectly.
ERROR!	Measurement error.
U>500V!	Before measurement, voltage at test terminals exceeds 500 V.
VOLTAGE!	Voltage exceeded.

3.10 Insulation resistance



WARNING

The tested object must not be live.

3.10.1 Settings of measurements

1



Select item **Riso**.

2

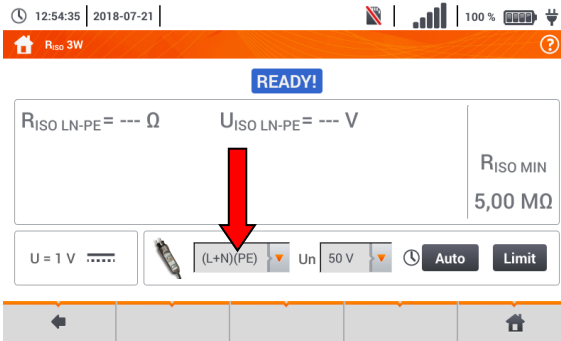

Connect the meter probe or the adapter which the measurements will be performed with.

Touch the drop down menu to set the measuring mode.

Positions will vary depending on whether the following have been connected to the meter:

- a) probes,
- b) UNI-Schuko adapter,
- c) AutoISO-1000c adapter

3a

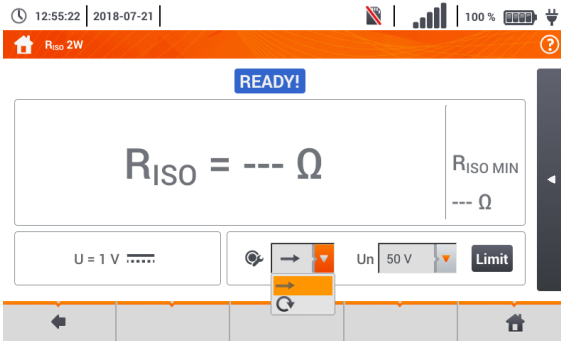

If **separate leads with probes** have been connected to the meter, select the required option from the menu:

- single measurement mode,
- ↻ continuous measurement mode.

3b

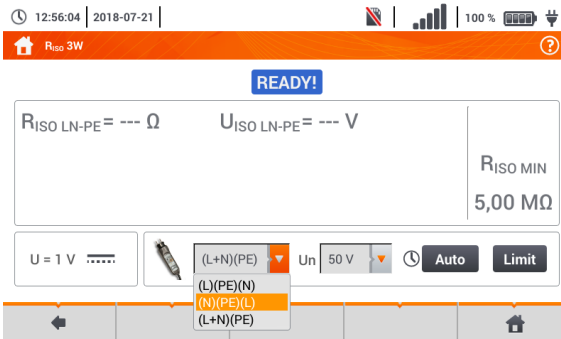

If **UNI-Schuko** adapter has been connected to the meter, select the required option from the menu:

- ⇒ **(L)(PE)(N)** – if the **phase** conductor on the **left** relative to the socket protective pin,
- ⇒ **(N)(PE)(L)** – if the **phase** conductor on the **right** relative to the socket protective pin,
- ⇒ **(L+N)(PE)** – shorted L and N conductors, measurement to PE (simplified method).

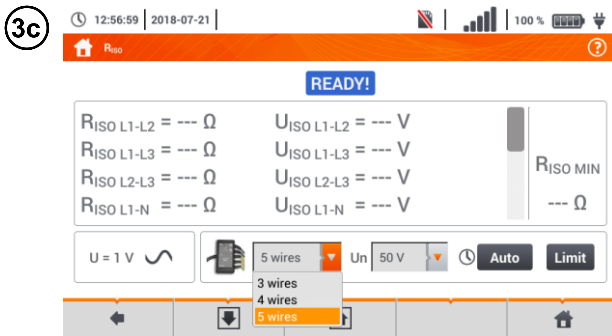

If **AutoISO** adapter has been connected to the meter, select the required option from the menu:

- ⇒ **3 wires** – measuring a 3-core cable,
- ⇒ **4 wires** – measuring a 4-core cable,
- ⇒ **5 wires** – measuring a 5-core cable.

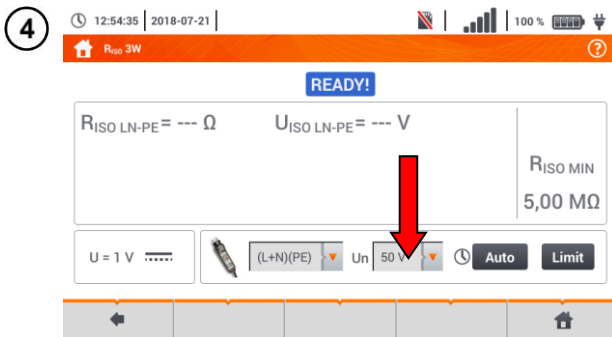

Touch the drop down menu to set the measuring voltage **Un**.

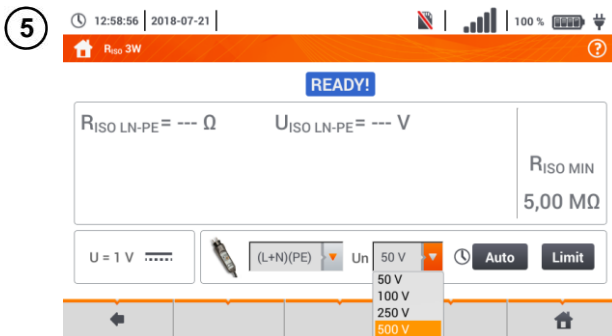

Select the required measuring voltage from the list.

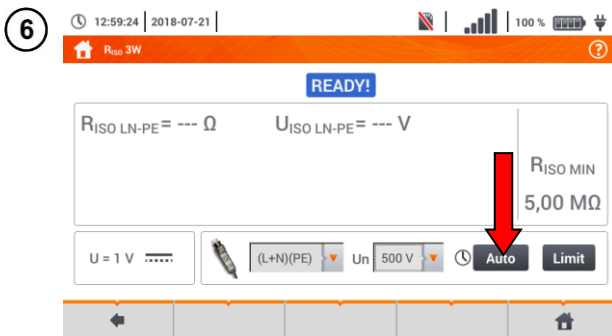

Set the measurement duration using the icon. After the selection has been made, it will display the set value.

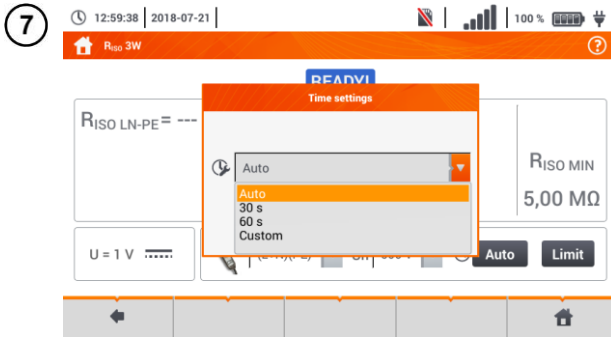

Available options

- ⇒ **Auto** – the meter automatically selects measurement duration depending on the capacity of the object measured
- ⇒ 30 s
- ⇒ 60 s
- ⇒ **Custom** – manual setting of time within the range of 1...60 s

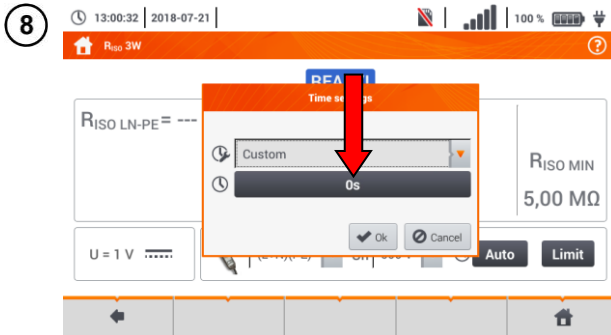

If the **Custom** option has been selected, enter the required time.

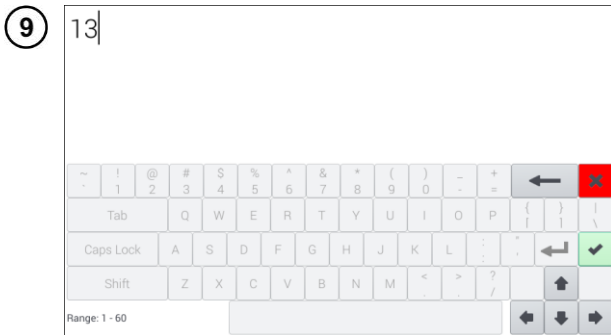

Delete the previous time value and enter a new one from the range of 1...60 s.

Functions of icons

- reject changes and exit to the previous screen
- accept changes

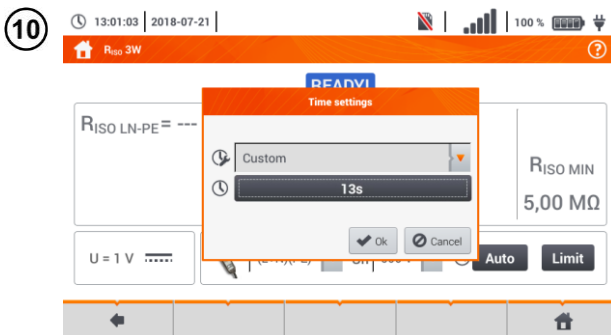

Description of function icons

- Ok** – accept selection
- Cancel** – reject changes

11

13:01:28 | 2018-07-21



Select **Limit** to set the acceptable insulation resistance criterion.

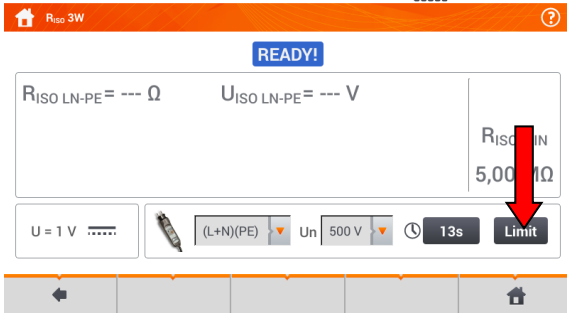

12



- Select unit.
- Delete the previous value and enter a new one. Ranges:
 - ⇒ **kΩ**: 0...2 000 000,
 - ⇒ **MΩ**: 0.0...2000.0,
 - ⇒ **GΩ**: 0.000...2.000.

Functions of icons

- rejecting changes and exit to the previous screen
- accepting changes

13

13:05:58 | 2018-07-21



- returning to the previous screen
- going to the main menu

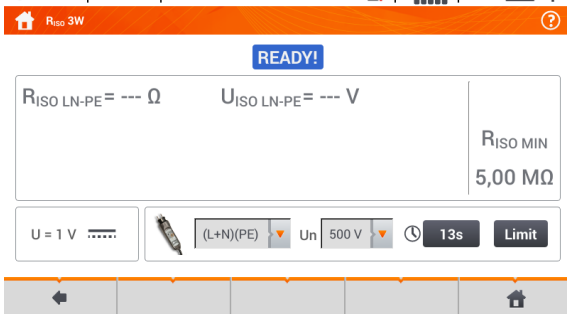

3.10.2 Measurement using probes



WARNING

- During measurements of insulation resistance, dangerous voltage up to 1 kV occurs at the ends of test leads of the meter.
- **It is forbidden** to disconnect test leads before the measurement is completed. Failure to obey the above instruction will lead to **electric shock with high voltage** and make it impossible to discharge the tested object.

①



Select item **R_{ISO}** to call up the measurement menu.

②

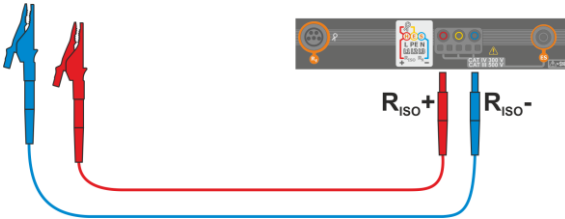

Connect the probes to the meter.

③

Enter the measurement settings in accordance with **section 3.10.1**

④

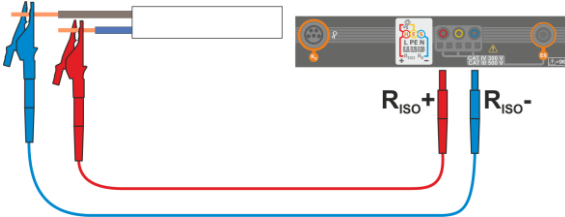

Connect test leads according to the drawing.

⑤



Press and hold the START button.

The measurement is performed continuously when the **START** is held in the pressed position.

In order to **interrupt** the measurement, press **START**.

If continuous measurement has been selected (icon ) , a **prompt** will appear to confirm the start of the measurement.

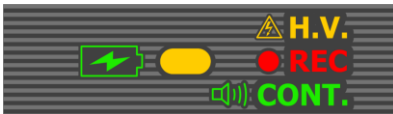

During the measurement the **H.V./REC/CONT.** diode is lit in **orange**.

6

13:16:03 | 2018-07-21 |



Read the measurement result.

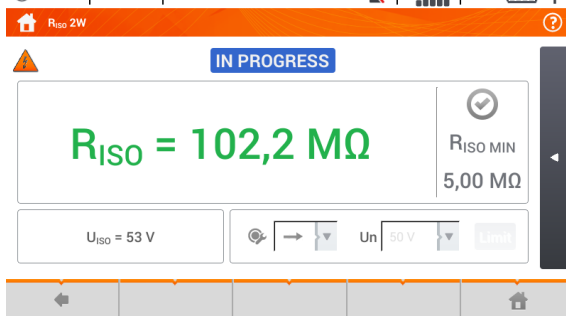

Signal lights for reaching the limit
([section 3.10.1 step \(11\)](#))

- the result is within the set limit
- the result is outside the set limit
- assessment not possible

If continuous measurement has been selected (icon), the measurement can be stopped by selecting the icon.



- The meter emits a continuous audio signal until test voltage reaches 90% of the preset value (and also when 110% of the preset value is exceeded).
- After completion of measurement, the capacitance of the object tested is discharged by shorting **Riso+** and **Riso-** terminals with resistance of 100 kΩ.

Additional information displayed by the meter

READY!	The meter is ready for measurement.
IN PROGRESS	Measurement in progress.
	Too high voltage detected on terminals of the meter. Disconnects the terminals from the test object.
NOISE!	Interference voltage occurs on the tested object. Measurement is possible but may be burdened with additional uncertainty.
LIMIT!	Current limit tripped. The symbol displayed during the measurement is accompanied by a continuous beep. If it is displayed after the measurement, it means that the measurement result was obtained during operation with a current limiting device (e.g. short circuit on the test object).

3.10.3 Measurements using UNI-Schuko adapter (WS-03 and WS-04)



WARNING

- During measurements of insulation resistance, dangerous voltage up to 500 V occurs at the ends of test leads of the meter.
- **It is forbidden** to disconnect test leads before the measurement is completed. Failure to obey the above instruction will lead to **electric shock with high voltage** and make it impossible to discharge the tested object.

①



Select item **R_{ISO}**, to call up the measurement menu.

②

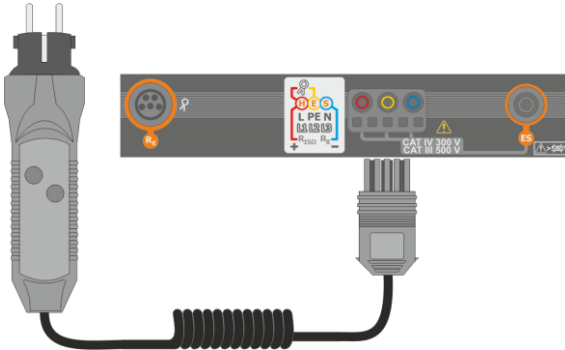

Connect **WS-03 adapter** or **WS-04 adapter** with UNI-Schuko outlet plug.

The meter detects this fact automatically and changes the appearance of the screen.

③

Enter the measurement settings in accordance with **section 3.10.1**

④

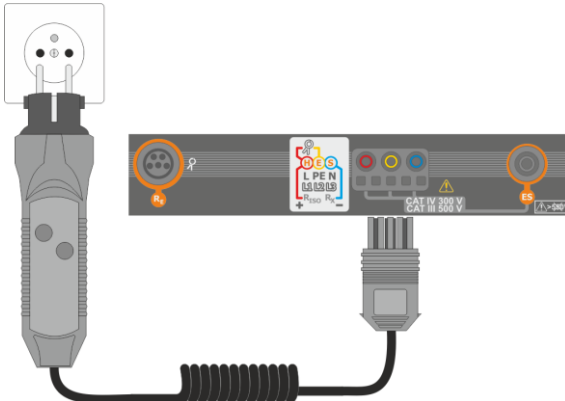

Connect the adapter to the test socket.

5



Press **START** to start measurement.

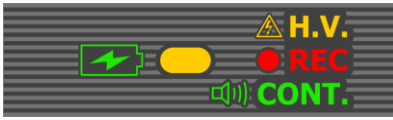

If any of the voltages exceeds allowable voltage value (50 V), **Object under voltage** message is displayed and the measurement is blocked.

During the measurement the **H.V./REC/CONT.** diode is lit in **orange**.

6

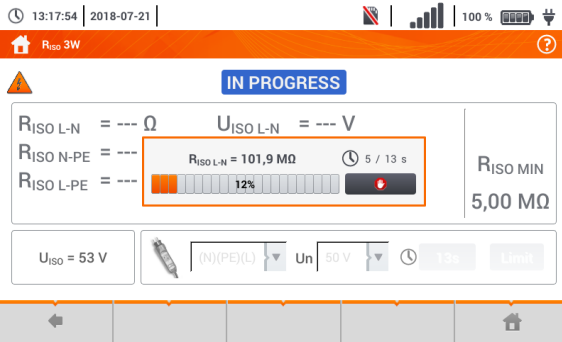

View of the screen during measurement.

The display shows the symbol of the resistance being measured and the progress bar of this measurement.

The progress bar indicates the status of the measurement.

The measurement may be cancelled at any time using the icon.

7

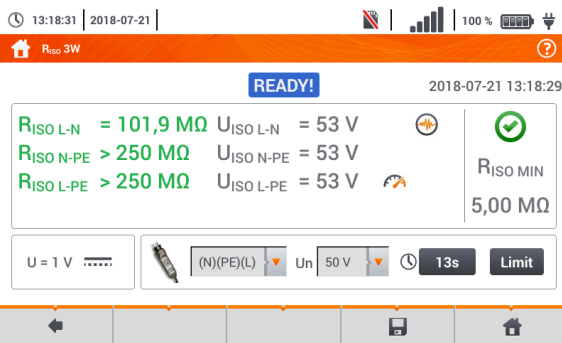

Read out the results.

Signal lights for reaching the limit (section 3.7.1 step 4)

- the result is within the set limit
- the result is outside the set limit
- assessment not possible

Additional signal lights for each of the measured lead pairs

- noise** – too strong interference signal recorded
- limit** – measurement taken at inverter current limit (e.g. short circuit in the test object)



8

Save the measurement to the meter memory using the icon. A detailed description of memory management is contained in **section 5.3**. The last measurement can be recalled using the icon.



- The meter emits a continuous audio signal until test voltage reaches 90% of the preset value (and also when 110% of the preset value is exceeded).
- After completion of measurement, the capacitance of the object tested is discharged by shorting **Riso+** and **Riso-** terminals with resistance of 100 kΩ.

Additional information displayed by the meter

READY!	The meter is ready for measurement.
IN PROGRESS	Measurement in progress.
	Too high voltage detected on terminals of the meter. Disconnects the terminals from the test object.
	Interference voltage occurs on the tested object. Measurement is possible but may be burdened with additional uncertainty.
	Current limit tripped. The symbol displayed during the measurement is accompanied by a continuous beep. If it is displayed after the measurement, it means that the measurement result was obtained during operation with a current limiting device (e.g. short circuit in the test object).

3.10.4 Measurements using AutoISO-1000c



WARNING

- During measurements of insulation resistance, dangerous voltage up to 1 kV occurs at the ends of test leads of the meter.
- **It is forbidden** to disconnect test leads before the measurement is completed. Failure to obey the above instruction will lead to electric shock with high voltage and make it impossible to discharge the tested object.

1



Select item **Riso**, to call up the measurement screen.

2

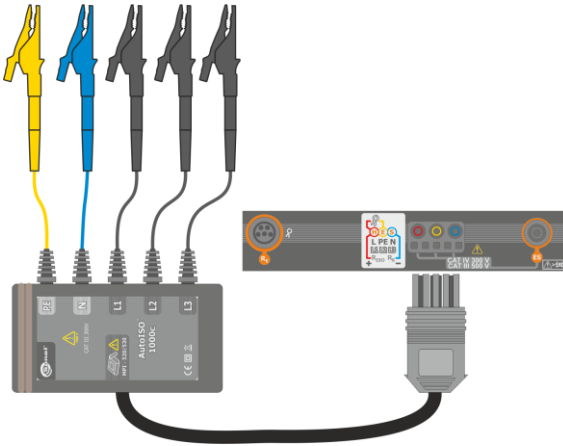

Connect **AutoISO-1000c** adapter.

The meter detects this fact automatically and changes the appearance of the screen.

3

Enter the measurement settings in accordance with **section 3.10.1**.

4

The meter is ready for measurement.



Live mode

U – interference voltage

Description of function icons

- ↓ scrolling down the list of measurements
- ↑ scrolling up the list of measurements

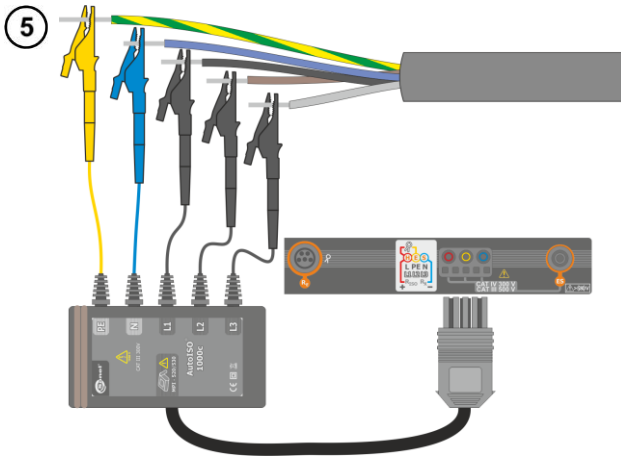

Connect AutolSO-1000c adapter to the lead tested.



Press **START** to start measurement.

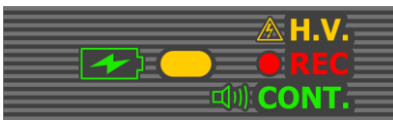

During the measurement the **H.V./REC/CONT.** diode is lit in **orange**.

If any of the voltages exceeds allowable voltage value (50 V), **Object under voltage** message is displayed and the measurement is blocked.

First, checking of voltages on particular pairs of wires is performed. If any of the voltages exceeds allowable voltage, the symbol of this voltage is displayed (e.g. **VOLTAGE! L1PE**), and the measurement is interrupted.

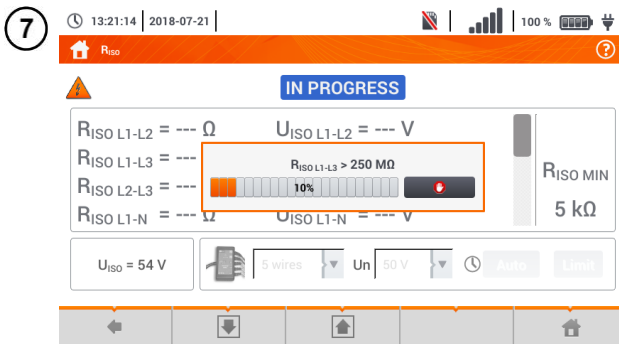

View of the screen during measurement.

The display shows the symbol of the resistance being measured and the progress bar of this measurement.

The bar shows % of progress of total measurement.

The measurement may be cancelled at any time using the  icon.

8

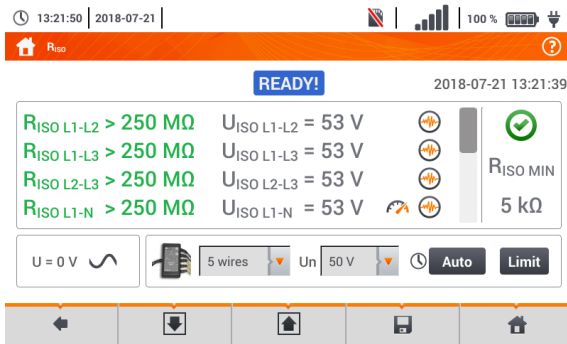

Read out the results.

Signal lights for reaching the limit (section 3.7.1 step 4)

- the result is within the set limit
- the result is outside the set limit
- assessment not possible

Additional signal lights for each of the measured lead pairs

- noise – too strong interference signal recorded
- limit – measurement taken at inverter current limit (e.g. short circuit in the test object)

9

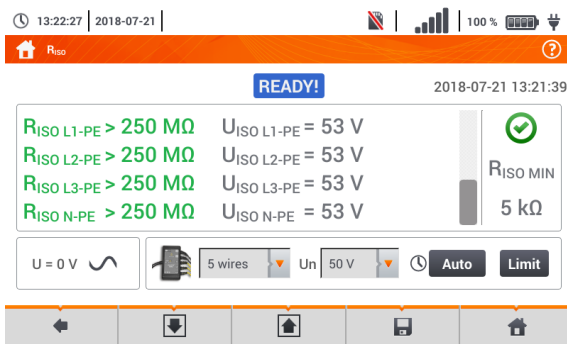

Using the slider or icons scroll the screen to read other measurement results.





10

Save the measurement to the meter memory using the icon. A detailed description of memory management is contained in section 5.3. The last measurement can be recalled using the icon.



- The meter emits a continuous audio signal until test voltage reaches 90% of the preset value (and also when 110% of the preset value is exceeded).
- After completion of measurement, the capacitance of the object tested is discharged by shorting R_{iso+} and R_{iso-} terminals with resistance of 100 kΩ.

Additional information displayed by the meter

	The meter is ready for measurement.
	Measurement in progress.
	Too high voltage detected on terminals of the meter. Disconnects the terminals from the test object.
	Interference voltage occurs on the tested object. Measurement is possible but may be burdened with additional uncertainty.
	Current limit tripped. The symbol displayed during the measurement is accompanied by a continuous beep. If it is displayed after the measurement, it means that the measurement result was obtained during operation with a current limiting device (e.g. short circuit in the test object).

3.11 Low-voltage resistance measurement

3.11.1 Resistance measurement

①



Select item **R_x**, to call up the measurement screen.

②

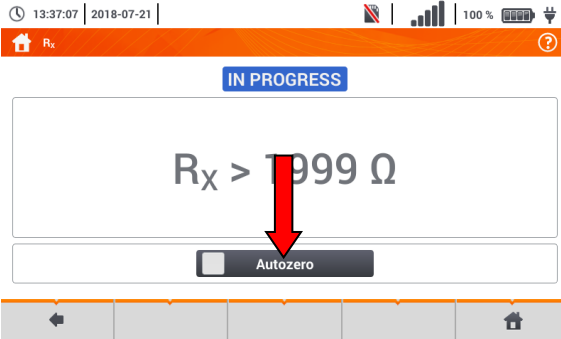

Select **Autozero** to eliminate the resistance of test leads.

③



Follow the on-screen prompts.

Description of function icons

Yes – accept selection

No – cancels the action

After selecting **Yes** the meter will give the **result reduced** by the resistance of test leads.

④

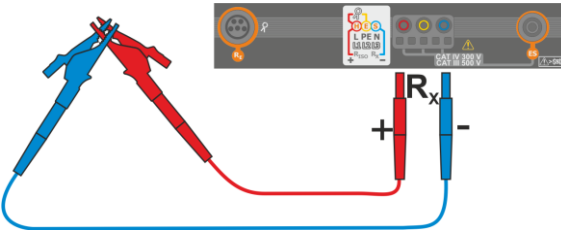

To **disable compensation** of the resistance of leads, repeat steps ② ③ ④ with **open** test leads. Then the measurement result will **contain the resistance of test leads**.

5

13:41:12 | 2018-07-21



The meter is ready for measurement.

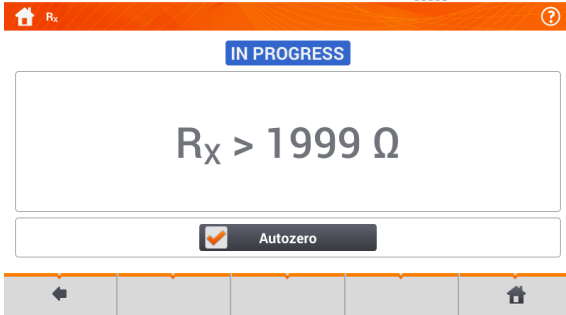

6

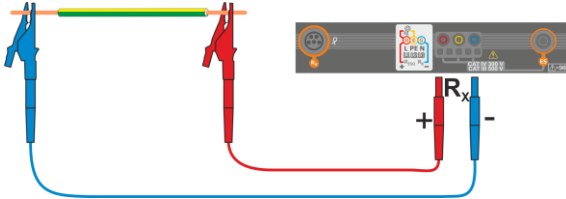

• Connect the meter to the tested object.

• Measurement starts automatically.

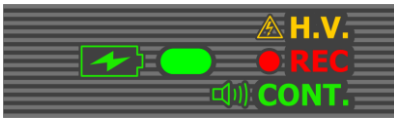

• During the measurement the **H.V./REC/CONT. diode** is lit **green** and a sound signal is emitted.

7

13:41:39 | 2018-07-21



Read out the result.

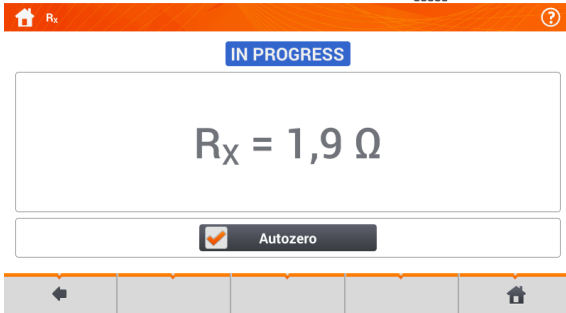

NOTE!

Display of symbols  **VOLTAGE!** indicates that the tested object is live. The measurement is blocked. The meter must be **immediately disconnected from the object**.



- If the **Autozero** option was **not deselected**, (steps ②③④), the meter invariably **reduces** the measurement result by the resistance of the previously connected test leads. Therefore, for each change of the leads, the **Autozero** procedure must be repeated.
- The correction factor is also remembered after restarting the function and/or the meter.
- If the test leads have been changed to such of a **lower** resistance than the previous ones but the **Autozero** procedure has not been performed, the meter will **understate** the value of the measurement. In extreme cases, the meter may indicate a **negative resistance**. Similarly, **greater** resistance of the leads causes an **overstated** result of the measurements.
- Maximum compensation of test leads resistance (Autozero) equals 500 Ω .

Additional information displayed by the meter

IN PROGRESS

Measurement in progress

VOLTAGE!

Incorrect voltage on object.

NOISE!

Interference voltage occurs on the tested object. The measurement is possible however it will be burdened with additional uncertainty that is specified in the technical data.

3.11.2 Measurement of resistance of protective conductors and equipotential bonding with ± 200 mA current

1



Select item **R_{CONT}**, to call up the measurement screen.

2

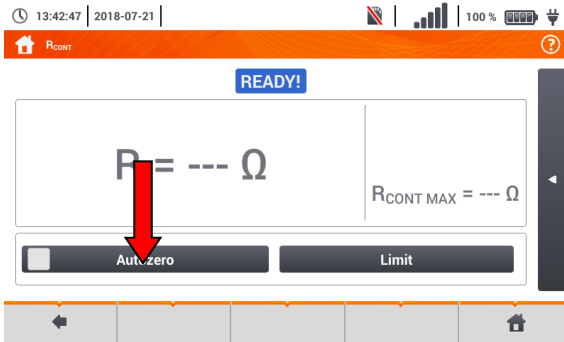

In order to eliminate the impact of the resistance of test leads on measurement result, the compensation (autozeroing) of resistance may be performed. For this purpose, select **Autozero**.

3



Follow the on-screen prompts.

Description of function icons

Yes – accept selection

No – cancels the action

After selecting **Yes** the meter will measure resistance of test leads 3 times. Then it will give the **result reduced** by this resistance.

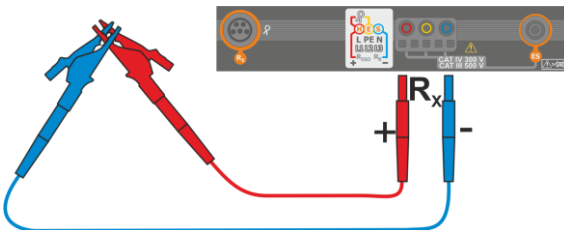

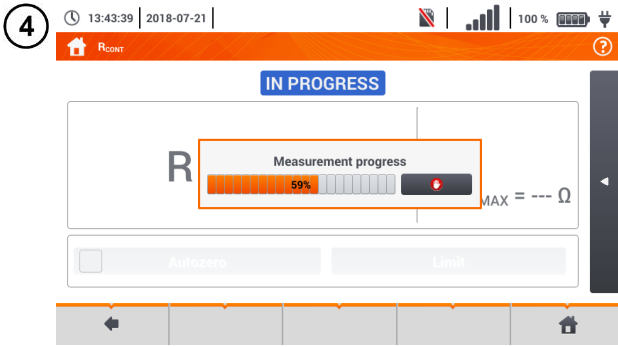

To **disable compensation** of the resistance of leads, repeat steps ② ③ with **open** test leads. Then the measurement result will **contain the resistance of test leads**.

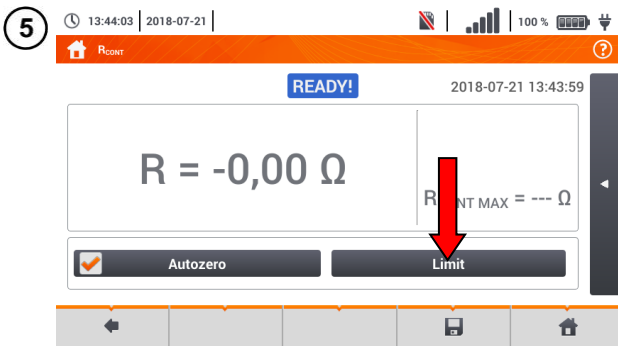

Set the acceptable limit resistance of the measured object.

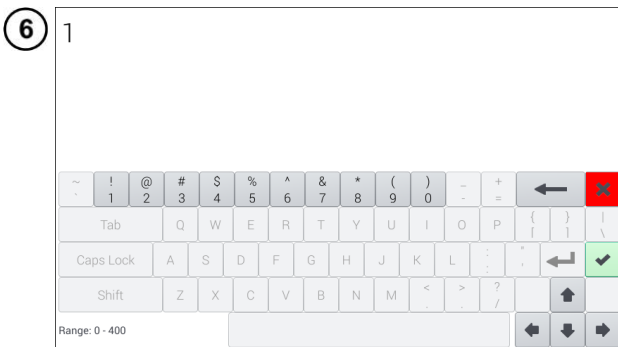

Using the on-screen keyboard delete the existing value and enter the required one.

Range: 0...400 Ω

Functions of icons

 reject changes and exit to the previous screen

 accept changes

7

13:44:53 | 2018-07-21 |



The meter is ready for measurement.

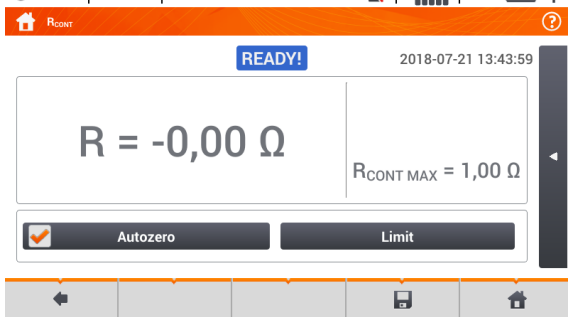

8

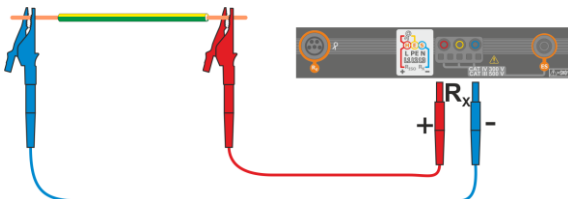

- Connect the meter to the tested object.
- Measurement starts automatically.

9

13:46:16 | 2018-07-21 |



Read the measurement result.

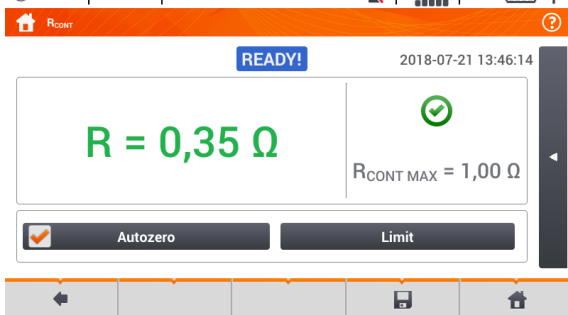

The result is the arithmetic mean of the values of two measurements at a current of 200 mA with opposite polarities R_F and R_R .

$$R = \frac{R_F + R_R}{2}$$

Signal lights for the limit (step 5).

- ✔ the result is within the set limit
- ✘ the result is outside the set limit
- ⊖ assessment not possible

After selecting the bar ◀ on the right side, a menu will slide out with additional measurement results.

10

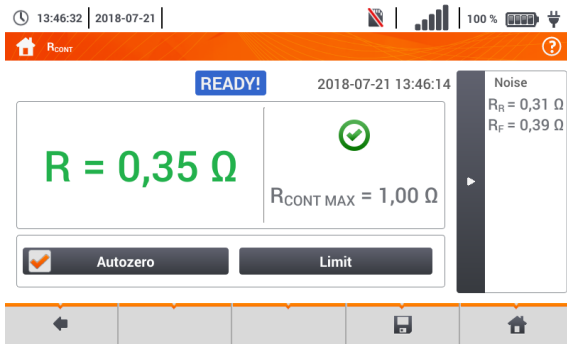

R_F – result obtained for a **positive** polarity of the measuring current
 R_R – result obtained for a **negative** polarity of the measuring current

Selecting the bar hides the menu.

11

Save the measurement to the meter memory using the icon. A detailed description of memory management is contained in **section 5.3**.

The last measurement can be recalled using the icon.

12



Press the **START** button in order to start the **next measurement** without disconnecting test leads from the object and proceed to step **(8)**.



NOTE!

Display of symbols **VOLTAGE!** indicates that the tested object is live. The measurement is blocked. The meter must be **immediately disconnected from the object**.



- If the **Autozero** option was **not deselected**, (steps **(2)(3)(4)**), the meter invariably **reduces** the measurement result by the resistance of the connected test leads. Then, for each change of the leads, the **Autozero** procedure must be repeated.
- The correction factor is also remembered after restarting the function and/or the meter.
- If the test leads have been changed to such of a **lower** resistance than the previous ones but the **Autozero** procedure has not been performed, the meter will **understate** the value of the measurement. In extreme cases, the meter may indicate a **negative resistance**. Similarly, **greater** resistance of the leads causes an **overstated** result of the measurements.
- Maximum compensation of test leads resistance (Autozero) equals 500 Ω.

Additional information displayed by the meter

READY!	The meter is ready for measurement.
IN PROGRESS	Measurement in progress.
VOLTAGE!	Too high voltage on the tested object.
NOISE!	Interference voltage occurs on the tested object. The measurement is possible however it will be burdened with additional uncertainty that is specified in the technical data.

3.12 Phase sequence

1



Select item **Phase sequence**, to call up the measurement screen.

2 Connect the meter to the installation according to the drawing.

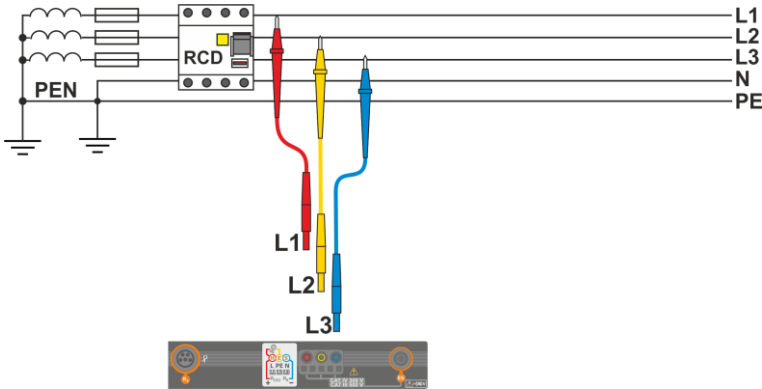

3

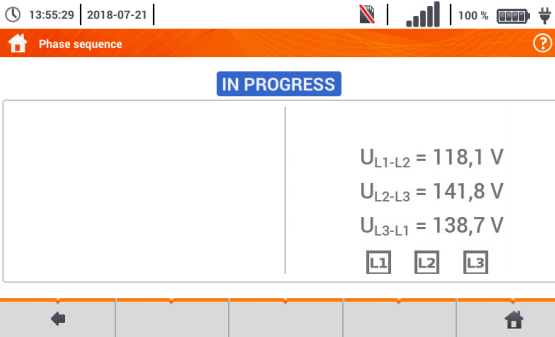

The meter ready for testing.

U_{L1-L2} , U_{L2-L3} , U_{L3-L1}
values of phase-to-phase voltages

L1 **L2** **L3**
signalling the presence of individual phases

4a

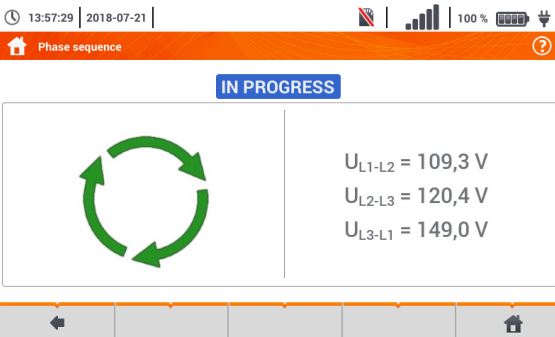

The phase sequence is **correct**, i.e. the phase sequence is in **clockwise** direction.

4b

13:58:39 | 2018-07-21 |



Phase sequence



The phase sequence is **incorrect**, i.e. the phase sequence is in **anticlockwise** direction.

IN PROGRESS

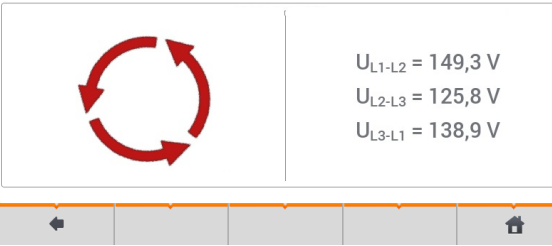

3.13 Motor rotation direction

1



Select item **Motor rotations**, to call up the measurement screen.

2

14:03:12 | 2018-07-21 |



Engine spin



The meter ready for testing.

IN PROGRESS



3

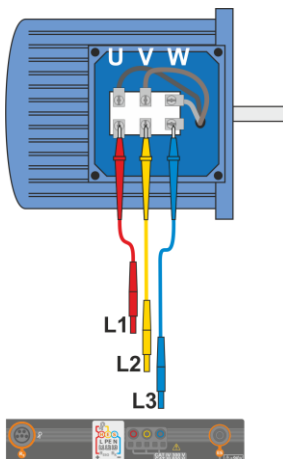

- Connect the meter to the motor according to the drawing, i.e. U terminal do input L1, V to L2, W to L3.
- Vigorously rotate the motor shaft to the right.

4a

14:03:18 | 2018-07-21



Engine spin

IN PROGRESS

$U_U = 13,1 \text{ V}$
 $U_V = 48,6 \text{ V}$
 $U_W = 26,0 \text{ V}$

Arrows on the screen rotating **to the right** mean that the motor connected to a 3-phase network will rotate the shaft **to the right**.

4b

14:08:12 | 2018-07-21



Engine spin

IN PROGRESS

$U_U = 13,1 \text{ V}$
 $U_V = 48,6 \text{ V}$
 $U_W = 26,0 \text{ V}$

Arrows on the screen rotating **to the left** mean that the motor connected to a 3-phase network will rotate the shaft **to the left**.



- Do not move the test leads during the test.
- Moving disconnected test leads, may induce voltages that result in indicating the direction of rotation.

3.14 Illuminance

1



Select item **Lux** to call up the measurement screen.

2



Connect the optical probe.

3



Select **Limit** to set the criterion of minimum illuminance.

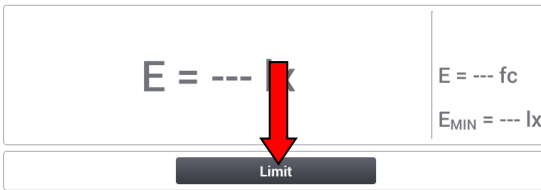

4

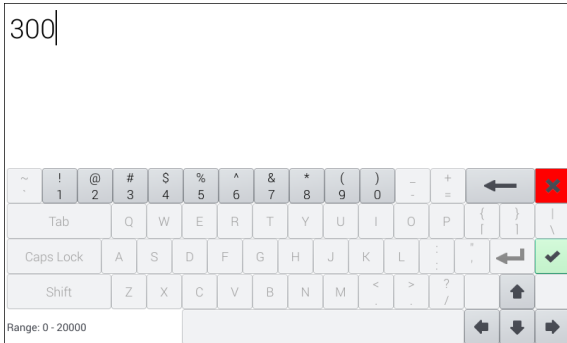

- Select unit.
- Delete the previous value and enter a new one from the range of 0...20 000 lx.

Functions of icons

- reject changes and exit to the previous screen
- accept changes

5

14:12:54 | 2018-07-21



Luxmeter

The meter is ready for light measurement.

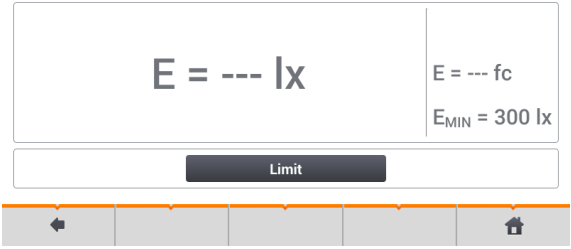

Live mode

E [lx] – illumination expressed in lux (lm/m²)

E [fc] – illumination expressed in lm/ft² (lumen per square foot)

E_{MIN} – limit set in steps (3) (4)

6

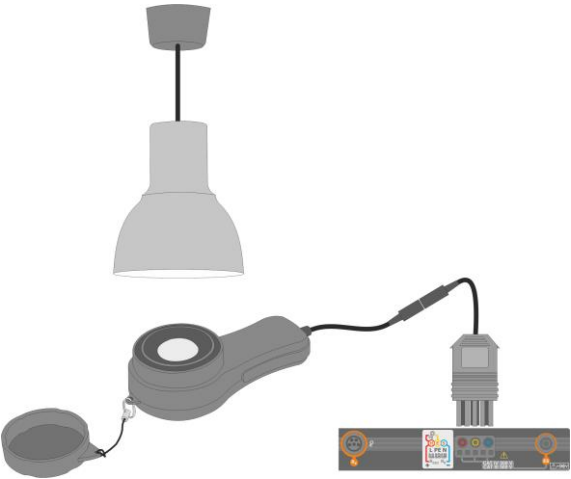

Place the probe in the test work plane.

7

14:13:10 | 2018-07-21



Luxmeter

Read out the result.

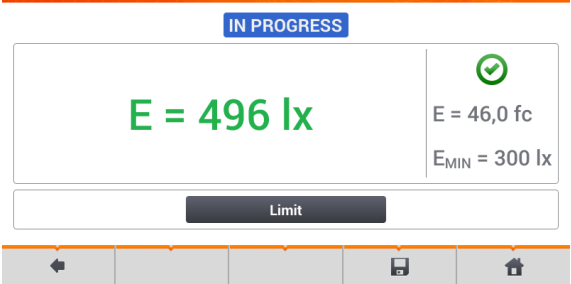

Signal lights for the limit (step 3)

✔ the result is within the set limit

✘ the result is outside the set limit

⊖ assessment not possible

8

Save the measurement to the meter memory using the  icon. A detailed description of memory management is contained in **section 5.3**.

4 Auto measurements

The meter includes automated test procedures.

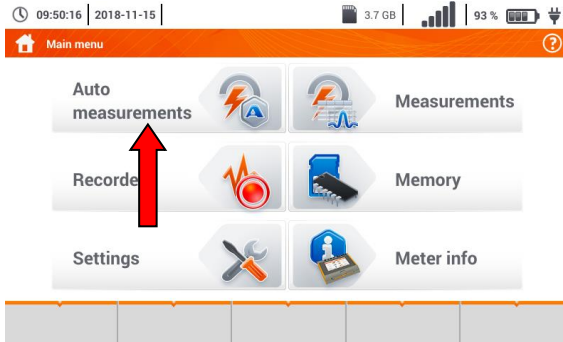

4.1 Proceeding auto measurements

1 The screenshot shows the 'Auto measurements' screen. At the top, there is a status bar with the time 16:07:51, date 2020-03-26, 3.6 GB free, 100% battery, and signal strength. Below this is an orange header bar with a home icon, 'Auto measurements', and a help icon. The main content is a table with two columns: 'Name' and 'Modified'. The table contains two rows: 'TN/TT/IT' and 'EVSE'. Each row has a folder icon next to the name.

Name	Modified
TN/TT/IT	2020-03-26 15:35:03
EVSE	2020-03-26 15:35:03

The measurement sequences are grouped into two folders:
 ⇒ measurements in TN/TT/IT networks,
 ⇒ measurements dedicated for electric vehicles charging stations.

Select the measuring sequence from the list.

2 The screenshot shows the configuration screen for 'Auto measurement - Zln+ZlpeRCD'. At the top, there is a status bar with the time 10:04:48, date 2019-10-21, 100% battery, and signal strength. Below this is an orange header bar with a home icon, 'Auto measurement - Zln+ZlpeRCD', and a help icon. The main content is divided into two sections: 'ZLN' and 'ZLPE[RCD]'. Each section has a dropdown menu for 'Accessory', a dropdown for 'I_k (Un)', and a dropdown for 'I_a' with a 'B10' button. Below the sections is a navigation bar with a back arrow, a plus sign, a trash icon, and a home icon.

Connect the meter to the measuring system.

In each setting field, enter the type of measuring accessory, installation parameters and other required data.

Description of function icons

- assistance for a particular measurement
- collapsing setting fields
- expanding setting fields
- saving entered measurement data

Press **START**. The automatic measurement sequence will start.



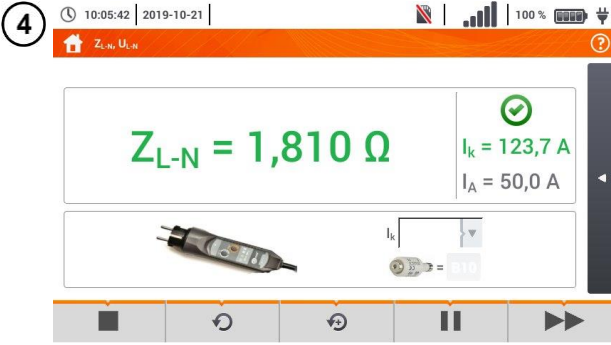

◀ The screen after completion of one of sequence measurements.

Description of function icons

- stopping the procedure and going to summary
- ↺ repeating the measurement with overwriting its result
- ↻ repeating the measurement without losing its previous result
- ⏸ stopping the procedure
- ▶▶ going to the next step of the procedure or to the summary. Time remaining to the next step is set according to **sec. 2.2.1.**

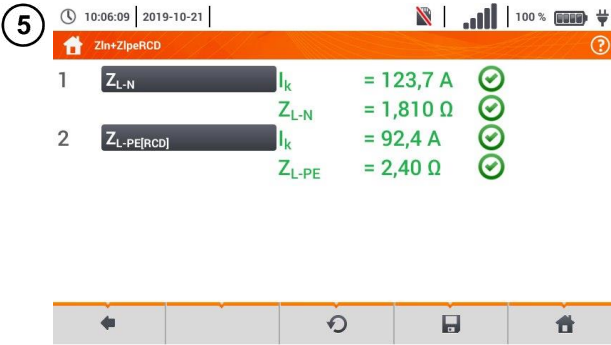

◀ Summary screen.

The procedure can be restarted with the ↺ icon.

Each measurement in a sequence hides partial results. To call them, touch the **label of such measurement**. A window as for a single measurement will be opened. Enter it with the use of the ◀ icon.

Save the measurement to the meter memory using the 💾 icon. A detailed description of memory management is contained in **section 5.3.**

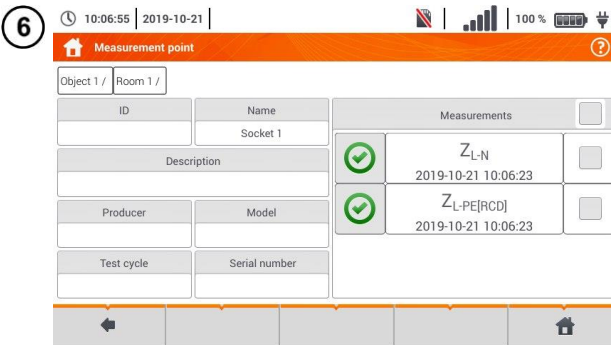

All sequence measurements will be saved in one measuring point.

Signal lights for reaching the limit

- ✔ the result is within the set limit
- ✘ the result is outside the set limit
- ⊖ assessment not possible
- no measurement was made

4.2 Creating measurement procedures

1

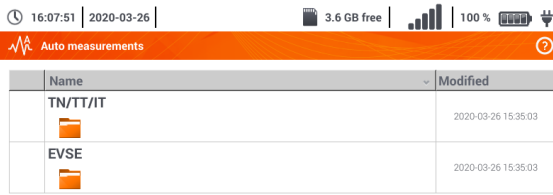

- Select **+**, to go to the sequence wizard.

- Select **+**, to add the desired measurement procedure.



2



From the available items select the one, which is to be a part of the procedure. In addition to standard measurements, the following are also available:

- ⇒ text message,
- ⇒ visual test.

3

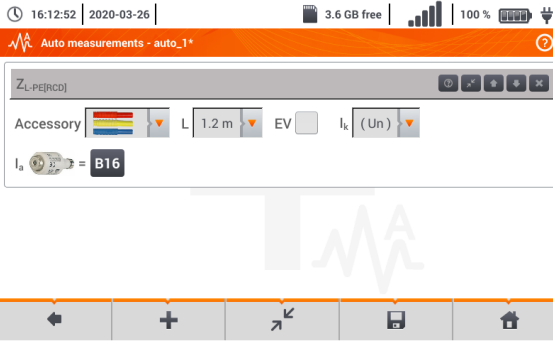

After each selection, the menu with step parameters will be shown.

If the tests contain measurements in electric vehicle charging stations, then **EV** box should be selected.

Description of function icons

- assistance for a particular measurement
- collapsing setting fields
- expanding setting fields
- saving entered measurement data

4

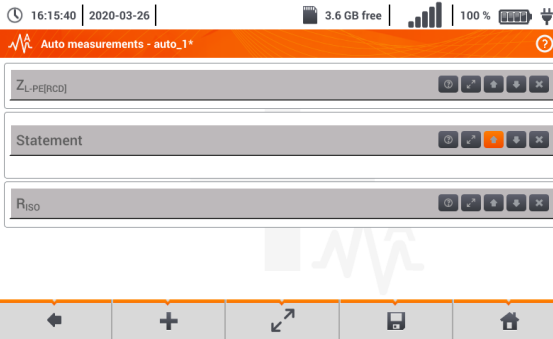

Changing the order of the steps is performed by using icons. Delete the step by using icon.

Save the procedure by using icon. A window will be shown requesting the name of the procedure.

5

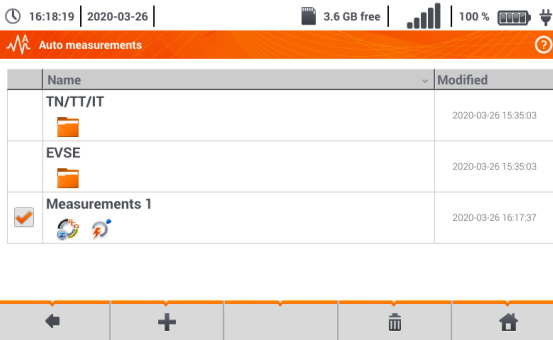

The procedure will be available from the main menu of auto-procedures. To remove it, select it with and choose .

5 Memory of the meter

5.1 Memory settings

① 14:03:04 | 2018-07-21 | 7.1 GB | 44% | In the main menu select **Settings**.

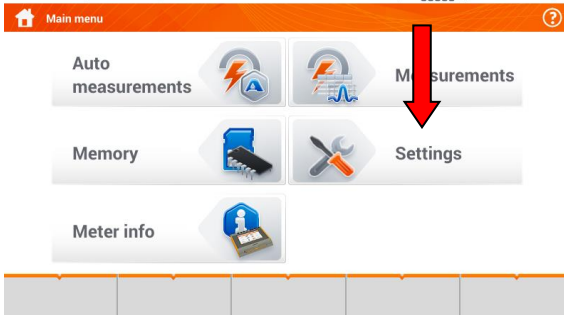

② **Memory settings** Select **Memory settings**.



③ 13:23:00 | 2018-07-22 | 97% | Two options will appear.

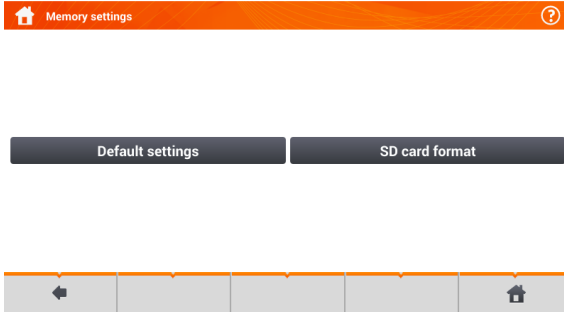

- **Default settings** – restores the meter memory to default memory settings. When this option has been selected, a prompt will appear asking to confirm the selection.
- **SD card format**. When this option has been selected, a prompt will appear asking to confirm that the user wants to format the SD card.

Description of function icons

- ◀ return to the previous screen
- 🏠 return to the main menu

5.2 Structure of the Memory

The memory of measurement results is of a tree structure (**Fig. 5.1**). The user can record an unlimited number of clients. Any number of objects with sub-objects can be created in each client.

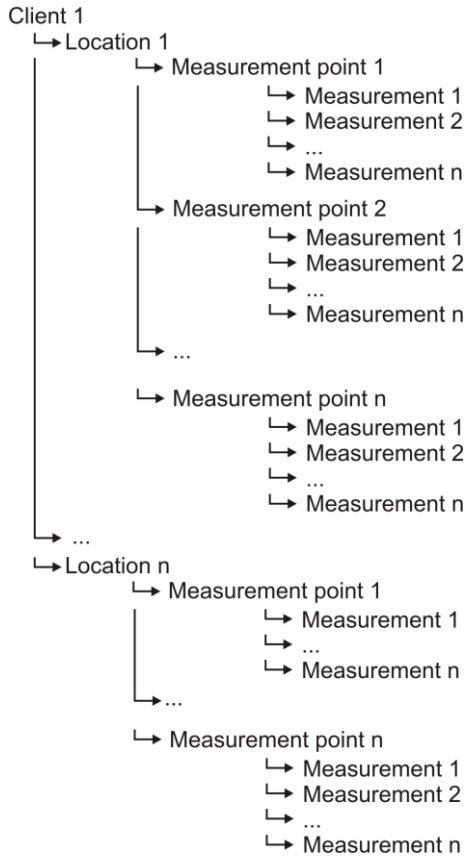
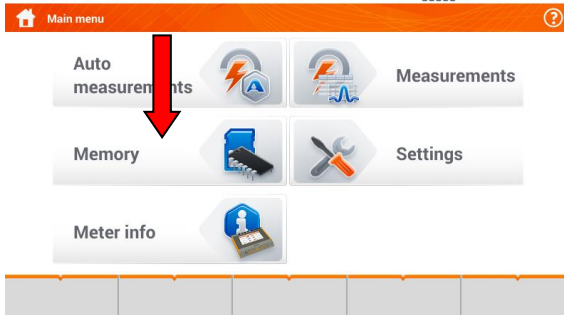

Fig. 5.1. Structure of meter memory for a single client

5.2.1 Fundamentals of navigating the Memory menu

1 14:03:04 | 2018-07-21 | 7.1 GB | 44% | Select **Memory** in the main menu.



2 13:25:51 | 2018-07-22 | 98% | Memory management panel will appear.

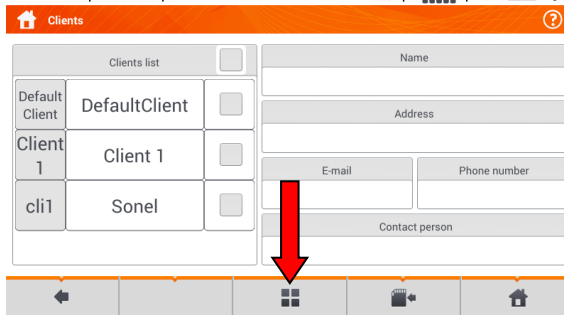

Description of function icons

- item inactive
- item active
- returning to the previous screen
- going to a lower level of the active item
- going to the folder tree of the active client
- returning to the main menu
- recording the active item to the SD card
- expanding the active item management menu

3

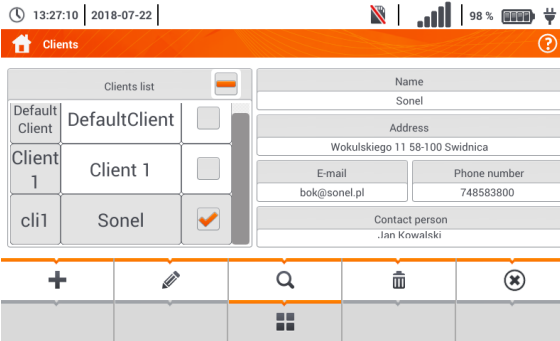

Description of icons in the edit menu

- + adding a new client
- editing the active client
- search mode (**section 5.4**)
- removing the active client
- closing the menu

4

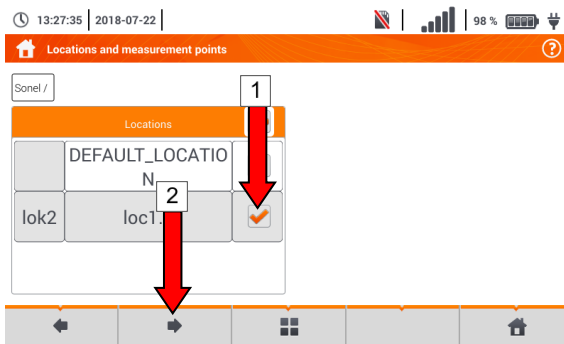

To go to a lower level of the folder tree:

- activate the required item (→)
- select the icon.

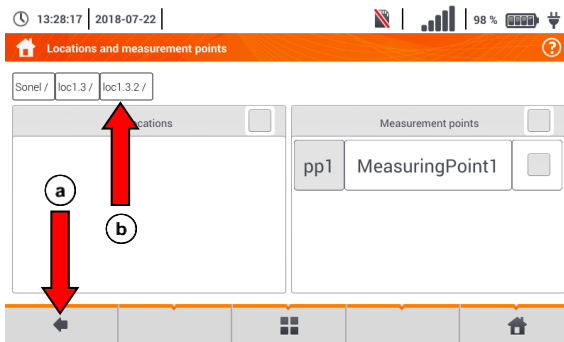

a) To go to a higher level of the folder tree, select the icon.

b) To move several levels up, select the name of the required folder on the top navigation bar.

5.2.2 Adding a new measurements tree

1  13:32:49 | 2018-07-22 |    98%   Add a new client using the **+** icon.

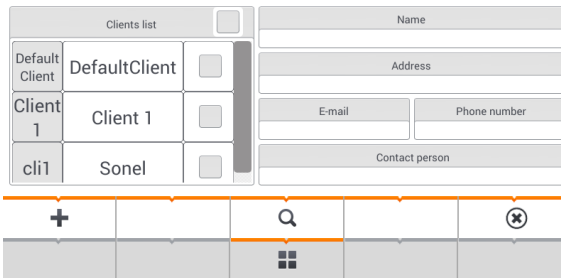

2  13:33:06 | 2018-07-22 |    98%   Tap and complete the required fields using the on-screen keyboard:



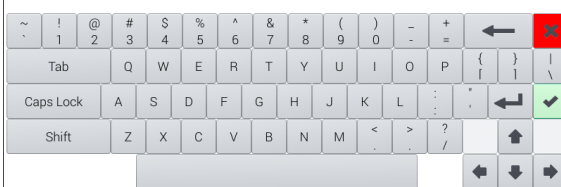

- ⇒ Client ID,
- ⇒ name,
- ⇒ address:
- ⇒ city,
- ⇒ postal code,
- ⇒ phone number,
- ⇒ e-mail,
- ⇒ contact person.

3 Enter the name from the touch keypad (holding certain buttons for a longer time triggers Polish characters).



Functions of icons

-  rejecting changes and returning to step 2
-  accepting changes and going to step 4

4

13:35:24 | 2018-07-22

Add client

ID	Name	
cli2	Sonel S.A.	
Address	City	Zip code
Wokulskiego 11	Swidnica	58-100
Phone number	E-mail	Contact person
+48748583800	export@sonel.pl	John Smith

Navigation icons: back, save, home

- Save changes using the  icon.

- The display will return to the client management menu.

5

13:35:52 | 2018-07-22

Clients

Clients list			Name
Default Client	DefaultClient	<input type="checkbox"/>	Sonel S.A.
Client 1	Client 1	<input type="checkbox"/>	Wokulskiego 11 58-100 Swidnica
cli2	Sonel S.A.	<input checked="" type="checkbox"/>	E-mail: export@sonel.pl Phone number: +48748583800
cli1	Sonel	<input type="checkbox"/>	Contact person: John Smith

Navigation icons: back, checkmark, grid, save, home

- Tap to activate the selected client (→)

- Select icon  and  to edit data.

- Further actions are the same as in steps 2, 3, 4.

- To go to the lower level of the tree:

- ⇒ tap the label of the required item,
- ⇒ activate the required item and select .

6

13:36:13 | 2018-07-22

Locations and measurement points

Sonel S.A. /

Locations	
DEFAULT_LOCATIO	<input type="checkbox"/>
N	<input type="checkbox"/>

Navigation icons: back, grid, home

- Creating a new client results in creating a default location for the measurements.

7

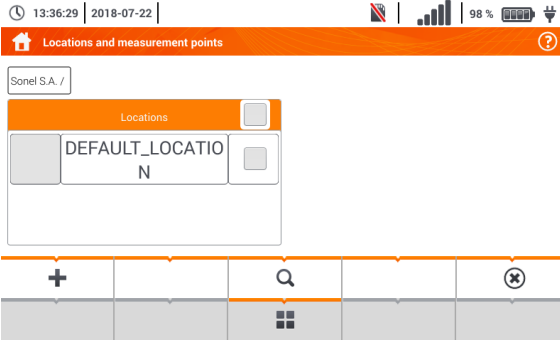

To add a new location:

- tap to activate the **Location** column,
- expand the edit menu using the  icon and select **+**,
- proceed as in steps **(2)(3)**.

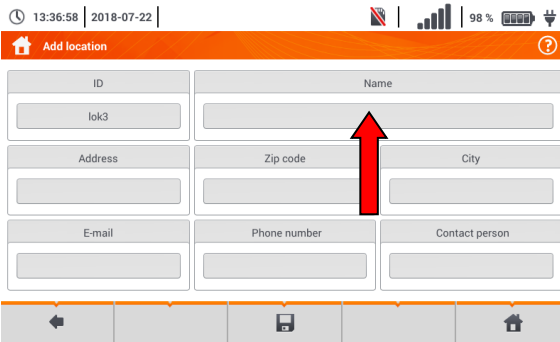

8



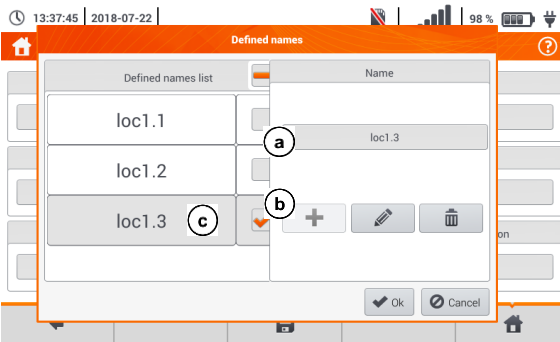

In the **Name** field the list of names for further use may be defined.

9



- (a)** Tap the name creation field and add a new name, the same as in step **(3)**.
- (b)** Using the **+** icon add the created item to the list of names.
- (c)** Select the required item and using the icons:
 edit the name,
 remove the name.

Tap to assign a location from the list to a required location of the tree ( → .

Ok – accept all changes.
Cancel – cancel changes.

10



- Save changes using the  icon.

- The display will return to the location management menu.

11

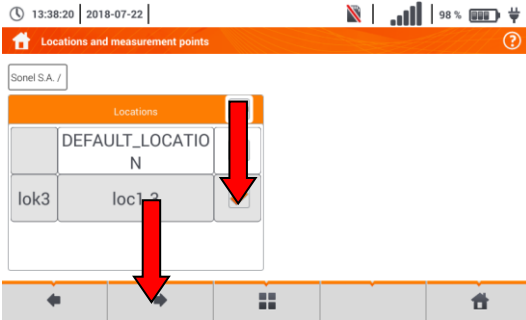

- Activate the required location ( → .

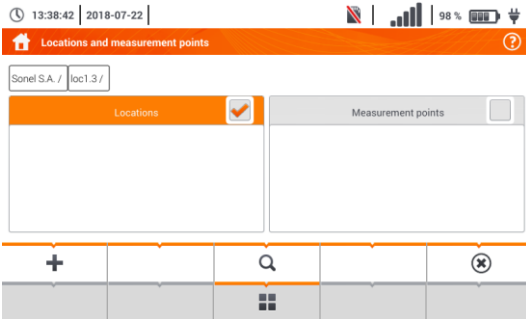

- Select  to go to the lower level of the tree.

12



The screen for locations and measuring points will appear.

- Tap to activate the **Location** column.

- Expand the edit menu using the  icon and select  ,

- Proceed as in steps (2)(3)(4) and (8)(9)(10).

13

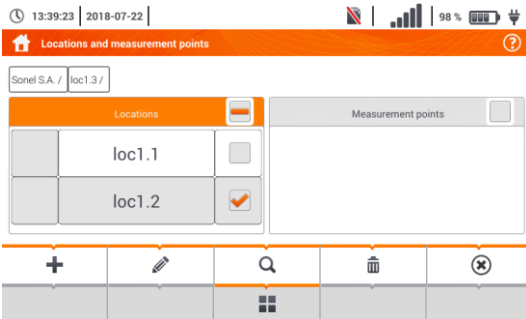



- Activate the required location ( → .

- Using the  icon, go to a lower level of the menu.

- If necessary, repeat steps (12)(13).

- Using the  icon expand the edit menu and select:

-  to edit location (as in steps (8)(9)(10)),

-  to enter the search mode (section 5.4),

-  remove.

14

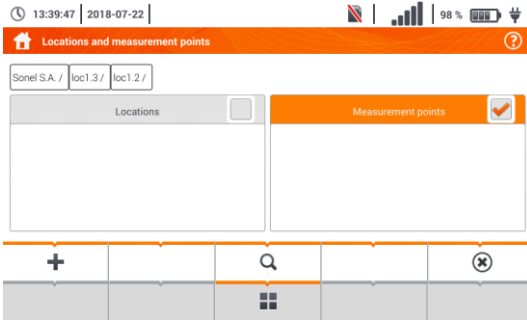

- Activate the column **Measurement points** (☐ → ☑).
- Using the ☐ icon expand the edit menu and select + to add a new measurement point (step 15).

15



Tap and complete the required fields using the on-screen keyboard:

- ⇒ point ID,
- ⇒ name,
- ⇒ description,
- ⇒ manufacturer,
- ⇒ model,
- ⇒ serial number,
- ⇒ measuring cycle,
- ⇒ year of manufacture,
- ⇒ safety class,
- ⇒ nominal voltage,
- ⇒ nominal current,
- ⇒ nominal power.

Description of function icons

- ← returning to the previous screen
- 💾 saving changes
- 🏠 returning to the main menu

The measuring point has been saved.

16

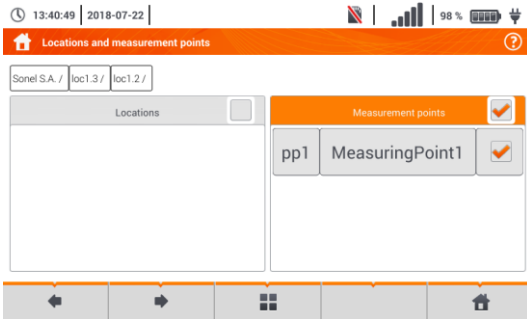

Description of icons in the edit menu

- + adding a new point
- ✎ editing the active point
- 🔍 search mode (**section 5.4**)
- 🗑 removing the active point.
- ⊗ closing the menu



- The results of measurements performed for all measuring functions can be stored in one cell of the **Measurement points** column.
- Only the results of measurements activated by pressing the **START** button can be stored in the memory (except autozeroing in low-voltage measurement of resistance).
- Complete set of results (main result and supplementary results) for a given measuring function, preset measurement settings, date and time of the measurement are stored in the memory.

5.3 Entering the measurement result



1

- After the measurement, select the  icon.
- The menu Entering the measurement result will appear (the menu and control the same as in **section 5.1**).

2

- If necessary, create a new location in accordance with **section 5.2.2**.

3

- Select the required measurement point from the location or create a new point in accordance with **section 5.2.2** step **14** **15** **16**.
- Tap  to save the result to memory.
- In case of cancellation, return to the measurement menu using the  icon.



Management of objects and sub-objects id possible both in the saving to memory mode and memory viewing (**section 5.4**).

5.4 Viewing saved measurements

1

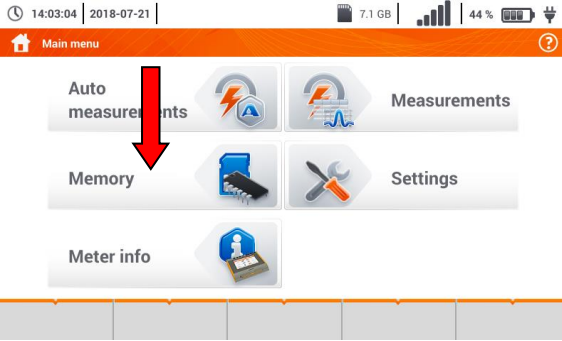

Select **Memory**.

2

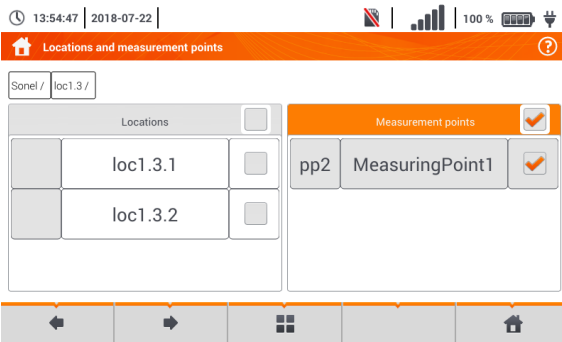

• Go to a location with a measuring point to which the measurement results were saved.

• Activate the required measuring point (→)

• Using the  icon, go to the contents of the measuring point.

3

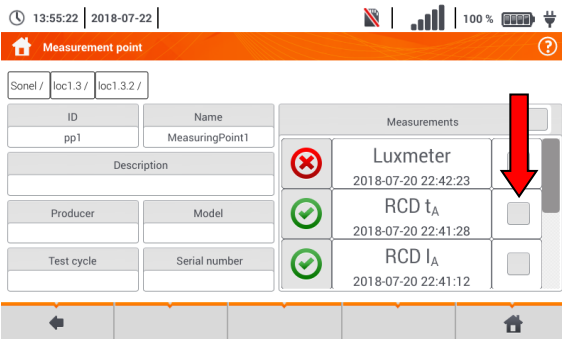

The list of measuring points contained in the active point will be displayed.

Description of controls signaling that the set limit has been reached.

condition fulfilled

condition unfulfilled

limit not defined

To call up the measurements management menu, activate the required records (→)

4

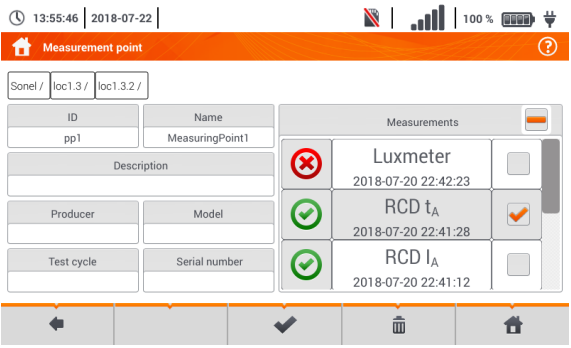

Description of function icons

- ← returning to the previous screen
- ✔ going to details (step 5)
- 🗑 removing the active record.
- 🏠 returning to the main menu

5

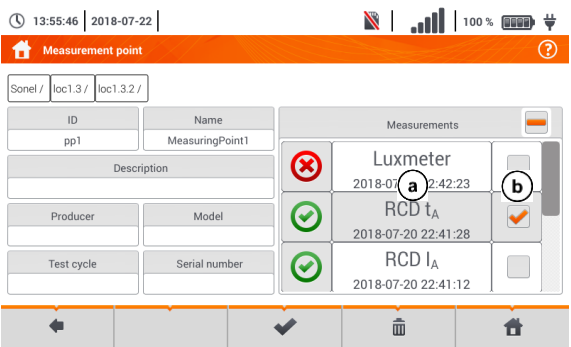

To go to the selected measurement result:

- a tap the record label,
- b activate the record (→) and select .

6

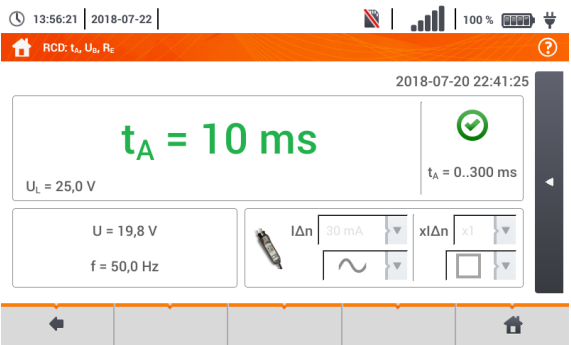





The value of the required measurement will be displayed.

5.5 Sharing recorded measurements





- Select . The following options are available:

  import of all clients from the memory card to the meter,

  export of selected clients to a memory card,

 sending selected customers via e-mail,

  generating a report in PDF format and sending it by e-mail.

- If necessary, select the customer (→) , which is to be subject to the requested action.
- Select the icon with the desired action.



Before sending data by e-mail, the Outbox must be configured. See **sec. 2.3.3**.

5.6 Searching the meter memory

1

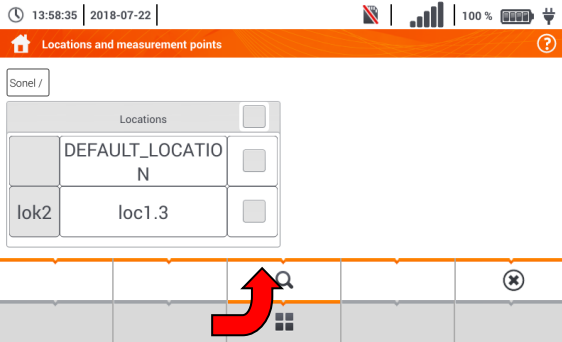

- From anywhere in the browse menu select  and .

2

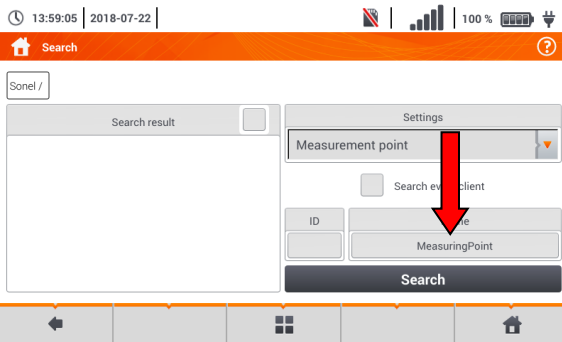

- The search menu will be displayed.

- In the **Settings** field, select the type of the searched object: **location** or **measuring point**.

- If necessary, select **Search all clients** (→)

- In the **Name** field, enter the searched phrase from the on-screen keyboard.

- Select **Search**.

3

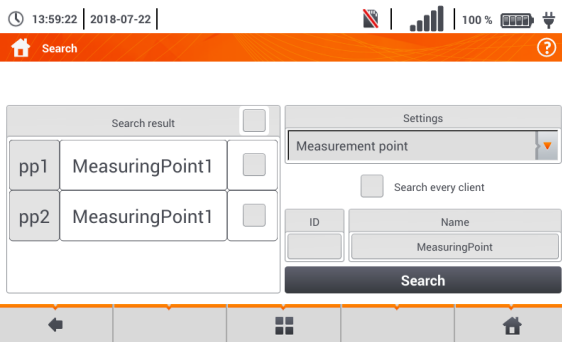



- Activate the required result (→)

- Go to details using the  icon.

- After the  icon has been selected, the option of record editing is also available in accordance with **section 5.2.2**, steps **8** **9** **10**.

Description of other function icons

 returning to the previous screen







 returning to the main menu

6 Power supply

6.1 Monitoring of the battery charge status

The device is equipped with a Li-Ion battery pack 11.1 V 3.4 Ah. The battery pack includes a circuit monitoring its charge status, which provides precise level of battery pack charge and a temperature sensor.

The charging level of the battery pack is indicated by icon on the top bar of the screen on the right side (**section 2** element 2).

	charging level 80...100%
	charging level 60...80%
	charging level 40...60%
	charging level 20...40%
	charging level 0...20%
	<ul style="list-style-type: none">• batteries fully discharged.• no battery• no communication with the battery pack

6.2 Replacing rechargeable batteries

MPI-535 meter is powered from SONEL Li-Ion rechargeable battery pack.

Battery charger is installed inside the meter and cooperates only with the manufacturer's rechargeable battery pack. The charger is powered by external power supply adapter. It can be also powered from the car cigarette lighter socket. Both the rechargeable battery pack and the adapter are standard components of the meter.



WARNING

If the test leads are left in the terminals during replacement of the batteries, there is a risk of electric shock.

The internal real time clock is supplied from the battery pack, therefore to avoid deleting the clock settings, the battery pack replacement may be performed with connected power supply of 12 V DC.

In order to replace the battery pack it is necessary to:

- remove all the test leads from the sockets and turn the meter off,
- connect the external power supply 12 V DC (to prevent deleting date and time settings)
- remove the four screws of the battery compartment (in the lower part of the casing), **Fig. 6.1**),
- remove the battery compartment,
- remove the compartment cover and remove the batteries,
- insert a new battery pack,
- Insert (snap) the compartment cover,
- Insert the compartment in the meter,
- screw the 4 screws of the battery compartment.

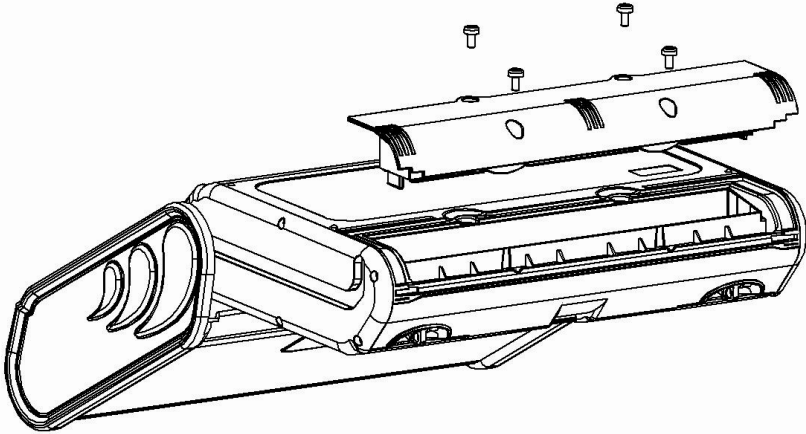

Fig. 6.1. Replacing the battery pack



NOTE!

Do not use the meter when the accumulator compartment is removed or open or power it from other sources than those mentioned in this manual.







6.3 Charging the rechargeable batteries

Charging the battery pack of the device is started automatically after connecting:

- 2 V DC power supply adapter,
- charging cable for the car cigarette lighter.

Charging is indicated by the  icon next to the battery symbol on the top bar and by the **H.V./REC/CONT.** diode. The temperature of the battery and the ambient temperature influence the charging process. If the battery temperature is below 0°C or higher than 45°C, the charging process is stopped.

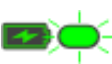
Indication of charging status

- charging
 - o meter off – diode **H.V./REC/CONT.** is lit **green**  
 - o meter on – charging signalled only by an icon on the display  
- damage
 - o meter off – diode **H.V./REC/CONT.** flashes **green** every 0.5 second 
 - o meter on – error signalled by an icon on the display 



Due to interferences in the network or to high ambient temperature, the charging process of rechargeable batteries may finish prematurely. When charging time is too short, turn off the meter and start charging again.

6.4 General rules for using Li-Ion rechargeable batteries

- Store the half-charged battery pack in a plastic container placed in a dry, cool and well ventilated place and protect them from direct sunlight. The battery pack may be damaged if stored when fully discharged. The ambient temperature for prolonged storage should be maintained within the range of 5°C...25°C.
- Charge the batteries in a cool, well-ventilated place at a temperature of 10°C ... 28°C. Modern fast chargers detect both too low and too high temperature of rechargeable batteries and react to the situation adequately. When the temperature is too low, charging should be prevented as it may irreparably damage the batteries. The increase in temperature of the battery pack may cause electrolyte leakage and even its ignition or explosion.
- Do not exceed the charging current, as it may result in ignition or "swelling" of the battery pack. "Swollen" battery pack must not be used.
- Do not charge or use the batteries in extreme temperatures. Extreme temperatures reduce the lifetime of rechargeable batteries. Always observe the rated operating temperature. Do not dispose the battery pack into fire.
- Li-Ion cells are sensitive to mechanical damage. This kind of damage may cause their permanent damage and thus - ignition or explosion.
- Any interference in the structure of Li-ion battery pack may cause its damage. This may result in the ignition or explosion.
- A short-circuit of the battery poles "+" and "-" may permanently damage the battery pack or even cause its fire or explosion.
- Do not immerse Li-Ion battery in liquids and do not store in humid conditions.
- If the electrolyte contained in the Lithium-Ion battery pack, contacts eyes or skin, immediately rinse the affected place with plenty of water and consult a doctor. Protect the battery against unauthorised persons and children.
- When you notice any changes in the Lithium-Ion battery pack (e.g. changes in colour, swelling, excessive temperature), stop using the battery pack. Li-Ion batteries that are mechanically damaged, overcharged or excessively discharged are not suitable for use.
- Any misuse of the battery may cause its permanent damage. This may result in the ignition. The seller and the manufacturer shall not be liable for any damages resulting from improper handling Li-Ion battery pack.

7 Cleaning and maintenance



NOTE!

Use only the maintenance methods specified by the manufacturer in this manual.

The meter has been designed for many years of reliable use, provided that the following recommendations are observed for its maintenance and care:

1. **THE METER MUST BE DRY.** Wipe the dampened meter.
2. **THE METER MUST BE USED AND STORED IN NORMAL TEMPERATURES.** Extreme temperatures may shorten the life of electronic components and distort or melt plastic parts.
3. **THE METER MUST BE HANDLED CAREFULLY AND GENTLY.** Dropping the meter may damage its electronic elements or the housing.
4. **THE METER MUST BE KEPT CLEAN.** From time to time wipe the housing with a damp cloth. DO NOT use chemicals, solvents or detergents.
5. **CLEAN THE PROBES WITH WATER AND DRY THEM** Before the probe is stored for a prolonged period of time it is recommended to grease it with any machine lubricant.
6. The reels and test leads should be cleaned with water and detergents, and then dried.



The electronic system of the meter does not require maintenance.

8 Storage

In the case of storage of the device, the following recommendations must be observed:

- Disconnect all the test leads from the meter.
- Clean the meter and all its accessories thoroughly.
- Wind the long test leads onto the reels.
- In the case the meter is to be stored for a prolonged period of time, the batteries must be removed from the device.
- In order to prevent a total discharge of the rechargeable batteries in the case of a prolonged storage, charge them from time to time.

9 Dismantling and utilisation

Worn-out electric and electronic equipment should be gathered selectively, i.e. it must not be placed with waste of another kind.

Worn-out electronic equipment should be sent to a collection point in accordance with the law of waste electrical and electronic equipment.

Before the equipment is sent to a collection point, do not dismantle any elements.

Observe the local regulations concerning disposal of packages and used batteries/rechargeable batteries.

10 Technical data

10.1 Basic data

⇒ Abbreviation "m.v." used in the specification of accuracy means standard measured value

10.1.1 Measurement of alternating voltages (True RMS)

Range	Resolution	Accuracy
0.0 V...299.9 V	0.1 V	±(2% m.v. + 4 digits)
300 V...500 V	1 V	±(2% m.v. + 2 digits)

- Frequency range: 45...65 Hz

10.1.2 Frequency measurement

Range	Resolution	Accuracy
45.0 Hz...65.0 Hz	0.1 Hz	±(0.1% m.v. + 1 digit)

- Voltage range: 50 ... 500V

10.1.3 Measurement of fault loop impedance Z_{L-PE} , Z_{L-N} , Z_{L-L}

Measurement of fault loop impedance Z_s

Test range according to IEC 61557-3:

Test lead	Test range Z_s
1.2 m	0.130 Ω ...1999.9 Ω
5 m	0.170 Ω ...1999.9 Ω
10 m	0.210 Ω ...1999.9 Ω
20 m	0.290 Ω ...1999.9 Ω
WS-03, WS-04	0.190 Ω ...1999.9 Ω

Display range:

Display range	Resolution	Accuracy
0.000...19.999 Ω	0.001 Ω	±(5% m.v. + 0.03 Ω)
20.00...199.99 Ω	0.01 Ω	±(5% m.v. + 0.3 Ω)
200.0...1999.9 Ω	0.1 Ω	±(5% m.v. + 3 Ω)

- Rated operating voltage U_{nL-N} / U_{nL-L} : 110/190 V, 115/200 V, 127/220 V, 220/380 V, 230/400 V, 240/415 V
- Operating voltage range: 95 V...270 V (for Z_{L-PE} and Z_{L-N}) and 95 V...440 V (for Z_{L-L})
- Rated mains frequency f_n : 50 Hz, 60 Hz
- Operating frequency range: 45 Hz...65 Hz
- Maximum test current (for 415 V): 41.5 A (10 ms)
- Control of correctness of PE terminal connection by means of a touch electrode

Indications of fault loop resistance R_s and fault loop reactance X_s

Display range	Resolution	Accuracy
0...19.999 Ω	0.001 Ω	±(5% + 0.05 Ω) of Z_s value

- Calculated and displayed for $Z_s < 20 \Omega$

Indications of short-circuit current I_k

Test range according to IEC 61557-3 can be calculated on the basis of test ranges for Z_s and nominal voltages.

Display range	Resolution	Accuracy
0.055 ... 1.999 A	0.001 A	Calculated on the basis of accuracy for fault loop
2.00...19.99 A	0.01 A	
20.0...199.9 A	0.1 A	
200...1999 A	1 A	
2.00...19.99 kA	0.01 kA	
20.0 ...40.0 kA	0.1 kA	

- Prospective fault current calculated and displayed by the meter may slightly differ from the value calculated by the user with a calculator, basing on the displayed value of the impedance, because the meter calculates the current from unrounded value of fault loop impedance (which is used for displaying). As the correct value, consider I_k current value, displayed by the meter or by firmware.

10.1.4 Measurement of fault loop impedance $Z_{L-PE[RCD]}$ (without triggering of RCD)

Measurement of fault loop impedance Z_s

Test range according to IEC 61557-3:

- 0.50...1999 Ω for 1.2 m leads, WS-03 and WS-04
- 0.51...1999 Ω for 5 m, 10 m and 20 m leads

Display range	Resolution	Accuracy
0...19.99 Ω	0.01 Ω	$\pm(6\% \text{ m.v.} + 10 \text{ digits})$
20.0...199.9 Ω	0.1 Ω	$\pm(6\% \text{ m.v.} + 5 \text{ digits})$
200...1999 Ω	1 Ω	

- It will not trip RCDs of $I_{\Delta n} \geq 30 \text{ mA}$
- Rated operating voltage U_n : 110 V, 115 V, 127 V, 220 V, 230 V, 240 V
- Operating voltage range: 95 V...270 V
- Rated mains frequency f_n : 50 Hz, 60 Hz
- Operating frequency range: 45...65 Hz
- Control of correctness of PE terminal connection by means of a touch electrode

Indications of fault loop resistance R_s and fault loop reactance X_s

Display range	Resolution	Accuracy
0..19.99 Ω	0.01 Ω	$\pm(6\% + 10 \text{ digits})$ of Z_s value

- Calculated and displayed for $Z_s < 20 \Omega$

Indications of short-circuit current I_k

Test range according to IEC 61557-3 can be calculated on the basis of test ranges for Z_S and nominal voltages.

Display range	Resolution	Accuracy
0.055 ... 1.999 A	0.001 A	Calculated on the basis of accuracy for fault loop
2.00...19.99 A	0.01 A	
20.0...199.9 A	0.1 A	
200...1999 A	1 A	
2.00...19.99 kA	0.01 kA	
20.0 ... 40.0 kA	0.1 kA	

- Prospective fault current calculated and displayed by the meter may slightly differ from the value calculated by the user with a calculator, basing on the displayed value of the impedance, because the meter calculates the current from unrounded value of fault loop impedance (which is used for displaying). As the correct value, consider I_k current value, displayed by the meter or by firmware.

10.1.5 Measurement of parameters of RCD

- Measurement of RCDs type: AC, A, B, B+, F, EV
- Rated operating voltage U_n : 110 V, 115 V, 127 V, 220 V, 230 V, 240 V
- Operating voltage range: 95 V...270 V
- Rated mains frequency f_n : 50 Hz, 60 Hz
- Operating frequency range: 45...65 Hz

RCD trigger and response time test t_A (for measurement function t_A)

Test range according to IEC 61557-6: 0ms ... to the upper limit of displayed value

Type of RCD	Setting of multiple values	Test range	Resolution	Accuracy
<ul style="list-style-type: none"> General type Short-time delay type AC module in EV type 	0.5 $I_{\Delta n}$	0..300 ms (TN/TT)	1 ms	$\pm(2\% \text{ m.v.} + 2 \text{ digits})^{1)}$
	1 $I_{\Delta n}$	0..400 ms (IT)		
	2 $I_{\Delta n}$	0..150 ms		
	5 $I_{\Delta n}$	0..40 ms		
Selective	0.5 $I_{\Delta n}$	0..500 ms		
	1 $I_{\Delta n}$			
	2 $I_{\Delta n}$			
	5 $I_{\Delta n}$			
<ul style="list-style-type: none"> EV 6 mA DC RCM 	1 $I_{\Delta n}$	0.0..10.0 s	0.1 s	$\pm(2\% \text{ m.v.} + 3 \text{ digits})$
	10 $I_{\Delta n}$	0..300 ms	1 ms	
	33 $I_{\Delta n}^{2)}$	0..100 ms		
	50 $I_{\Delta n}^{3)}$	0..40 ms		

1) for $I_{\Delta n} = 10 \text{ mA}$ and 0.5 $I_{\Delta n}$ accuracy is $\pm(2\% \text{ m.v.} + 3 \text{ digits})$

2) for measurements acc. to IEC 62955









3) for measurements acc. to IEC 62752









- Accuracy of differential current setting:

for 1* $I_{\Delta n}$, 2* $I_{\Delta n}$, 5* $I_{\Delta n}$ 0..8%

for 0.5* $I_{\Delta n}$ -8..0%

Effective value of forced leakage current at measurement of RCD disconnection time (does not apply to RCD EV 6 mA DC and RCM) [mA]

$I_{\Delta n}$	Multiplication factor setting							
	0.5				1			
								
10	5	3.5	3.5	5	10	20	20	20
30	15	10.5	10.5	15	30	42	42	60
100	50	35	35	50	100	140	140	200
300	150	105	105	150	300	420	420	600
500	250	175	175	—	500	700	700	1000*
1000	500	—	—	—	1000	—	—	—

$I_{\Delta n}$	Multiplication factor setting							
	2				5			
								
10	20	40	40	40	50	100	100	100
30	60	84	84	120	150	210	210	300
100	200	280	280	400	500	700	700	1000*
300	600	840	840	—	—	—	—	—
500	1000	—	—	—	—	—	—	—
1000	—	—	—	—	—	—	—	—

* - does not apply to $U_n = 110 \text{ V}$, 115 V and 127 V and IT network

Effective value of forced leakage current at measurement of RCD disconnection time (applies to RCD EV 6 mA DC and RCM) [mA]

$I_{\Delta n}$	Multiplication factor setting			
	1	10	33	50
6 mA DC acc. to IEC 62955	6	60	200	—
6 mA DC acc. to IEC 62752	6	60	—	300

Measurement of resistance-to-earth R_E (for TT)

Selected nominal current of RCD	Test range	Resolution	Test current	Accuracy
10 mA	0.01...5.00 k Ω	0.01 k Ω	4 mA	0..+10% m.v. ± 8 digits
30 mA	0.01...1.66 k Ω		12 mA	0..+10% m.v. ± 5 digits
100 mA	1...500 Ω	1 Ω	40 mA	0..+5% m.v. ± 5 digits
300 mA	1...166 Ω		120 mA	
500 mA	1...100 Ω		200 mA	
1000 mA	1...50 Ω		400 mA	

Measurement of touch voltage U_B in relation to nominal differential current

Test range according to IEC 61557-6: 10.0 V...99.9 V

Test range	Resolution	Test current	Accuracy
0...9.9 V	0.1 V	0.4 x $I_{\Delta n}$	0%...10% m.v. ± 5 digits
10.0...99.9 V			0%...15% m.v.

Measurement of RCD disconnection current I_A for sinusoidal differential current

Test range according to IEC 61557-6: $(0.3...1.0)I_{\Delta n}$

Selected nominal current of RCD	Test range	Resolution	Test current	Accuracy
10 mA	3.0..10.0 mA	0.1 mA	$0.3 \times I_{\Delta n}..1.0 \times I_{\Delta n}$	$\pm 5\% I_{\Delta n}$
30 mA	9.0 .. 30.0 mA			
100 mA	30..100 mA	1 mA		
300 mA	90..300 mA			
500 mA	150..500 mA			
1000 mA	300..1000 mA			

- it is possible to start the measurement from the positive of the negative half of forced leakage current
- test current duration..... max. 8.8 s

Measurement of RCD disconnection current I_A for differential unidirectional pulsed current and unidirectional pulsed current with 6mA direct current offset

Test range according to IEC 61557-6: $(0.35...1.4)I_{\Delta n}$ for $I_{\Delta n} \geq 30$ mA and $(0.35...2)I_{\Delta n}$ for $I_{\Delta n} = 10$ mA

Selected nominal current of RCD	Test range	Resolution	Test current	Accuracy
10 mA	3.5..20.0 mA	0.1 mA	$0.35 \times I_{\Delta n}..2.0 \times I_{\Delta n}$	$\pm 10\% I_{\Delta n}$
30 mA	10.5..42.0 mA			
100 mA	35..140 mA	1 mA	$0.35 \times I_{\Delta n}..1.4 \times I_{\Delta n}$	
300 mA	105..420 mA			
500 mA	175..700 mA			

- measurement may be performed for positive or negative half-periods of forced leakage current
- test current duration..... max. 8.8 s

Measurement of RCD disconnection current I_A for differential direct current

Test range according to IEC 61557-6: $(0.2...2)I_{\Delta n}$

Selected nominal current of RCD	Test range	Resolution	Current	Accuracy
6 mA ¹⁾	1.0..6.0 mA	0.1 mA	1.0..6.0 mA	$\pm 6\% I_{\Delta n}$
10 mA	2.0..20.0 mA	0.1 mA	$0.2 \times I_{\Delta n}..2.0 \times I_{\Delta n}$	$\pm 10\% I_{\Delta n}$
30 mA	6..60 mA	1 mA		
100 mA	20..200 mA			
300 mA	60..600 mA			
500 mA	100..1000 mA			

- measurement can be performed for positive or negative forced leakage current
 - test current duration (does not apply to RCD EV and RCM) max. 5.2 s
- ¹⁾ test current duration (applies to RCD EV and RCM)
- acc. to IEC 62955.....30 s
 - acc. to IEC 62752.....40 s

10.1.6 Measurement of resistance-to-earth R_E

Test range according to IEC 61557-5: 0.50 Ω ...1.99 k Ω for test voltage of 50 V and 0.56 Ω ...1.99 k Ω for test voltage of 25 V

Range	Resolution	Accuracy
0.00...0.35 Ω	0.01 Ω	$\pm(2\% \text{ m.v.} + 10 \text{ digits})$
0.35...9.99 Ω	0.01 Ω	$\pm(2\% \text{ m.v.} + 4 \text{ digits})$
10.0...99.9 Ω	0.1 Ω	$\pm(2\% \text{ m.v.} + 3 \text{ digits})$
100...999 Ω	1 Ω	
1.00...1.99 k Ω	0.01 k Ω	

- test voltage: 25 V or 50 V rms
- test current: 20 mA, sinusoidal rms 125 Hz (for $f_n=50$ Hz) and 150 Hz (for $f_n=60$ Hz)
- blocking of measurement at interference voltage of $U_N > 24$ V
- maximum measured voltage of interferences $U_{Nmax}=100$ V
- maximum resistance of auxiliary earth electrodes 50 k Ω

Measurement of resistance of auxiliary earth electrodes R_H, R_S

Display range	Resolution	Accuracy
000...999 Ω	1 Ω	$\pm(5\% (R_S + R_E + R_H) + 3 \text{ digits})$
1.00...9.99 k Ω	0.01 k Ω	
10.0...50.0 k Ω	0.1 k Ω	

Measurement of interference voltages

Internal resistance: approx. 8 M Ω

Range	Resolution	Accuracy
0...100 V	1 V	$\pm(2\% \text{ m.v.} + 3 \text{ digits})$

Selective measurement of earthing with clamps

Range	Resolution	Accuracy *
0.00...0.35 Ω	0.01 Ω	$\pm(8\% \text{ m.v.} + 10 \text{ digits})$
0.35...9.99 Ω	0.01 Ω	$\pm(8\% \text{ m.v.} + 4 \text{ digits})$
10.0...99.9 Ω	0.1 Ω	
100...999 Ω	1 Ω	
1.00...1.99 k Ω	0.01 k Ω	

* – at maximum interference current of 1 A

- Measurement with additional current clamps C-3,
- The range of interference current is up to 9.99 A.

Selective measurement of earthing with two clamps

Range	Resolution	Accuracy *
0.00...0.35 Ω	0.01 Ω	$\pm(10\% \text{ m.v.} + 10 \text{ digits})$
0.35...9.99 Ω	0.01 Ω	$\pm(10\% \text{ m.v.} + 4 \text{ digits})$
10.0...19.9 Ω	0.1 Ω	
20.0...99.9 Ω		$\pm(20\% \text{ m.v.} + 4 \text{ digits})$

* – at maximum interference current of 1 A

- Measurement with transmitting clamps N-1 and receiving clamps C-3.
- The range of interference current is up to 9.99 A.

Measuring soil resistivity (ρ)

Range	Resolution	Accuracy
0.0...99.9 Ωm	0.1 Ωm	Depending on the accuracy of the measurement R_E
100...999 Ωm	1 Ωm	
1.00...9.99 $\text{k}\Omega\text{m}$	0.01 $\text{k}\Omega\text{m}$	
10.0...99.9 $\text{k}\Omega\text{m}$	0.1 $\text{k}\Omega\text{m}$	

- Measurement with Wenner method,
- Option for setting the distance in meters or feet,
- Selecting a distance: 1 m ... 30 m (1 ft ... 90 ft).

10.1.7 Low-voltage measurement of continuity of circuit and resistance

Measurement of continuity of protective conductors and equipotential bonding with 200 mA \pm current

Measurement range according to IEC 61557-4: 0.12...400 Ω

Range	Resolution	Accuracy
0.00...19.99 Ω	0.01 Ω	$\pm(2\% \text{ m.v.} + 3 \text{ digits})$
20.0...199.9 Ω	0.1 Ω	
200...400 Ω	1 Ω	

- Voltage at open terminals: 4 V...9 V
- Output current at $R < 2 \Omega$: min. 200 mA (I_{sc} : 200 mA..250 mA)
- Compensation of test leads resistance
- Measurements for both current polarizations

Measurement of resistance with low current

Range	Resolution	Accuracy
0.0...199.9 Ω	0.1 Ω	$\pm(3\% \text{ m.v.} + 3 \text{ digits})$
200...1999 Ω	1 Ω	

- Voltage at open terminals: 4 V...9 V
- Output current $< 8 \text{ mA}$
- Audio signal for measured resistance $< 30 \Omega \pm 50\%$
- Compensation of test leads resistance

10.1.8 Measurement of insulation resistance

Measurement range, according to IEC 61557-2 for $U_N = 50 \text{ V}$: 50 k Ω ...250 M Ω

Display range for $U_N = 50 \text{ V}$	Resolution	Accuracy
0 k Ω ...1999 k Ω	1 k Ω	$\pm(3\% \text{ m.v.} + 8 \text{ digits})$, $[\pm(5\% \text{ m.v.} + 8 \text{ digits})]^*$
2.00 M Ω ...19.99 M Ω	0.01 M Ω	
20.0 M Ω ...199.9 M Ω	0.1 M Ω	
200 M Ω ...250 M Ω	1 M Ω	

* – for WS-03 and WS-04 leads

Test range according to IEC 61557-2 for $U_N = 100 \text{ V}$: 100 k Ω ...500 M Ω

Display range for $U_N = 100 \text{ V}$	Resolution	Accuracy
0 k Ω ...1999 k Ω	1 k Ω	$\pm(3\% \text{ m.v.} + 8 \text{ digits})$ $[\pm(5\% \text{ m.v.} + 8 \text{ digits})]^*$
2.00 M Ω ...19.99 M Ω	0.01 M Ω	
20.0 M Ω ...199.9 M Ω	0.1 M Ω	
200 M Ω ...500 M Ω	1 M Ω	

* – for WS-03 and WS-04 leads

Test range according to IEC 61557-2 for $U_N = 250 \text{ V}$: 250 k Ω ...999 M Ω

Display range for $U_N = 250 \text{ V}$	Resolution	Accuracy
0 k Ω ...1999 k Ω	1 k Ω	$\pm(3\% \text{ m.v.} + 8 \text{ digits})$ $[\pm(5\% \text{ m.v.} + 8 \text{ digits})]^*$
2.00 M Ω ...19.99 M Ω	0.01 M Ω	
20.0 M Ω ...199.9 M Ω	0.1 M Ω	
200 M Ω ...999 M Ω	1 M Ω	

* – for WS-03 and WS-04 leads

Test range according to IEC 61557-2 dla $U_N = 500 \text{ V}$: 500 k Ω ...2.00 G Ω

Display range for $U_N = 500 \text{ V}$	Resolution	Accuracy
0...1999 k Ω	1 k Ω	$\pm(3\% \text{ m.v.} + 8 \text{ digits})$ $[\pm(5\% \text{ m.v.} + 8 \text{ digits})]^*$
2.00...19.99 M Ω	0.01 M Ω	
20.0...199.9 M Ω	0.1 M Ω	
200...999 M Ω	1 M Ω	
1.00...2.00 G Ω	0.01 G Ω	$\pm(4\% \text{ m.v.} + 6 \text{ digits})$ $[\pm(6\% \text{ m.v.} + 6 \text{ digits})]^*$

* – for WS-03 and WS-04 leads

Test range according to IEC 61557-2 for $U_N = 1000 \text{ V}$: 1000 k Ω ...4.99 G Ω

Display range for $U_N = 1000 \text{ V}$	Resolution	Accuracy
0...1999 k Ω	1 k Ω	$\pm(3\% \text{ m.v.} + 8 \text{ digits})$
2.00...19.99 M Ω	0.01 M Ω	
20.0...199.9 M Ω	0.1 M Ω	
200...999 M Ω	1 M Ω	
1.00...4.99 G Ω	0.01 G Ω	$\pm(4\% \text{ m.v.} + 6 \text{ digits})$
5.00...9.99 G Ω	0.01 G Ω	unspecified

- Test voltage: 50 V, 100 V, 250 V, 500 V i 1000 V
- Accuracy of generated voltage (Robc [Ω] $\geq 1000 \cdot U_N$ [V]): -0% + 10% from the set value
- Detection of a dangerous voltage before commencing a measurement

- Discharging the object tested
- Measurement of insulation resistance with the use of UNI-Schuko plug (WS-03, WS-04) between all three terminals (for $U_N=1000$ V is not available)
- Insulation resistance measurement for multi-wire cables (max. 5) using an optional external AutoISO-1000c adapter
- Measurement of voltage on terminals $+R_{ISO}$, $-R_{ISO}$ within the range of: 0 V...440 V
- Test current < 2 mA

10.1.9 Light measurements

Measuring ranges of LP-1 probe

Range [lx]	Resolution [lx]	Spectral uncertainty	Accuracy
0...399.9	0.1	f1<6%	±(5% m.v. + 5 digits)
400...3999	1		
4.00 k...19.99 k	0.01 k		

Range [fc]	Resolution [fc]	Spectral uncertainty	Accuracy
0...39.99	0.01	f1<6%	±(5% m.v. + 5 digits)
40.0...399.9	0.1		
400...1999	1		

- Probe class B

Measuring ranges of LP-10B probe

Range [lx]	Resolution [lx]	Spectral uncertainty	Accuracy
0...39.99	0.01	f1<6%	±(5% m.v. + 5 digits)
40.0...399.9	0.1		
400...3999	1		
4.00 k...39.99 k	0.01 k		
40.0 k...399.9 k	0.1 k		

Range [fc]	Resolution [fc]	Spectral uncertainty	Accuracy
0...3.999	0.001	f1<6%	±(5% m.v. + 5 digits)
4.00...39.99	0.01		
40.0...399.9	0.1		
400...3999	1		
4.00 k...39.99 k	0.01 k		

- Probe class B

Measuring ranges of LP-10A probe

Range [lx]	Resolution [lx]	Spectral uncertainty	Accuracy
0...3.999	0.001	f1<2%	±(2% m.v. + 5 digits)
4.00...39.99	0.01		
40.0...399.9	0.1		
400...3999	1		
4.00 k...39.99 k	0.01 k		
40.0 k...399.9 k	0.1 k		

Range [fc]	Resolution [fc]	Spectral uncertainty	Accuracy
0...3.999	0.001	f1 < 2%	±(2% m.v. + 5 digits)
4.00...39.99	0.01		
40.0...399.9	0.1		
400...3999	1		
4.00 k...39.99 k	0.01 k		

- Probe class A

10.1.10 Phase sequence

- Phase sequence indication: in the same direction (correct), opposite direction (incorrect)
- Range of network voltages U_{L-L} : 95 V...500 V (45 Hz...65 Hz)
- Display of phase-to-phase voltages

10.1.11 Motor rotation

- EMF motor voltage ranges: 1 V ÷ 500 V AC
- Test current (per phase): <3.5 mA

10.2 Other technical data

- a) type of insulation double, according to EN 61010-1 and IEC 61557
- b) measurement category IV 300 V (III 500 V) according to EN 61010-2-030
- c) housing degree of protection for the housing acc. to EN 60529 IP51 (with closed sealing plug)
- d) meter power supply Li-Ion 11,1 V 3,4 Ah 37,7 Wh
- e) parameters of AC adapter for the battery charge 12 V DC / 2.5 A
..... 100 V...240 V, 50 Hz...60 Hz (mains)
- f) dimensions 288 mm x 223 mm x 75 mm
- g) weight of the meter with batteries approx. 2.5 kg
- h) storage temperature -20°C...+60°C
- i) operating temperature 0°C...+45°C
- j) temperature range suitable for initiating battery charging +10°C...+40°C
- k) temperatures at which the charging process is interrupted <+5 °C and ≥ +50°C
- l) humidity 20%...90%
- m) reference temperature +23°C ± 2°C
- n) reference humidity 40%...60%
- o) altitude (above sea level): <2000 m
- p) time until Auto-OFF 2 min, 5 min or off
- q) number of measurements Z or RCD (for batteries) >3000 (6 measurements/minute)
- r) number of measurements R_{ISO} or R (for charged batteries) >1000
- s) display colour LCD TFT, touchscreen
..... 800 x 480 pixels
..... diagonal 7"
- t) memory of measurement results unlimited
- u) data transmission USB
- v) quality standard design, construction and manufacturing are ISO 9001, ISO 14001, ISO 45001 compliant
- w) the device meets the requirements of standard IEC 61557
- x) the product meets EMC requirements (immunity for industrial environment) according to the following standards EN 61326-1 and EN 61326-2-2



EN 55022 Compliance statement

MPI-535 is a class A product. In a domestic environment this product may cause radio interference in which case the user may be required to take adequate measures (e.g. increasing the distance between affected products).



SONEL S.A. hereby declares that the radio device type MPI-535 complies with Directive 2014/53/EU. The full text of the EU Declaration of Conformity is available at the following website address: <https://sonel.pl/en/download/declaration-of-conformity/>

10.3 Additional data

Data on additional uncertainties are useful mainly when the meter is used in non-standard conditions and for metrological laboratories for the purpose of calibration.

10.3.1 Additional uncertainties according to IEC 61557-2 (R_{ISO})

Significant parameter	Designation	Additional uncertainty
Position	E ₁	0%
Supply voltage	E ₂	0%
Temperature 0°C...35°C	E ₃	2%

10.3.2 Additional uncertainties according to IEC 61557-3 (Z)

Significant parameter	Designation	Additional uncertainty
Position	E ₁	0%
Supply voltage	E ₂	0%
Temperature 0°C...35°C	E ₃	1.2 m lead – 0 Ω 5 m lead – 0.011 Ω 10 m lead – 0.019 Ω 20 m lead – 0.035 Ω WS-03 and WS-04 lead – 0.15 Ω
Phase angle 0°...30°	E _{6,2}	0.6%
Frequency 99%...101% f _n	E ₇	0%
Mains voltage 85%...110% U _n	E ₈	0%
Harmonic	E ₉	0%
DC component	E ₁₀	0%

10.3.3 Additional uncertainties according to IEC 61557-4 (R ±200 mA)

Significant parameter	Designation	Additional uncertainty
Position	E ₁	0%
Supply voltage	E ₂	0.5%
Temperature 0 °C...35 °C	E ₃	1.5%

10.3.4 Additional uncertainties of earth resistance measurement (R_E)

Additional uncertainties according to IEC 61557-5

Significant parameter	Designation	Additional uncertainty
Position	E ₁	0%
Supply voltage	E ₂	0%
Temperature 0 °C...35 °C	E ₃	0% for 50 V ± 2 digits for 25 V
Serial interference voltage	E ₄	±(6.5% + 5 digits)
Resistance of electrodes	E ₅	2.5%
Frequency 99%...101% f _n	E ₇	0%
Mains voltage 85%...110% U _n	E ₈	0%

Additional uncertainty caused by serial interference voltage for 3p, 4p, 3p+clamps functions
(for 25 V and 50 V)

R_E	Additional uncertainty
$<10 \Omega$	$\pm(((-32 \cdot 10^{-5} \cdot R_E + 33 \cdot 10^{-4}) \cdot U_Z^2 + (-12 \cdot 10^{-3} \cdot R_E + 13 \cdot 10^{-3}) \cdot U_Z) \cdot 100\% + 0,026 \cdot \sqrt{U_Z \Omega})$
$\geq 10 \Omega$	$\pm(((-46 \cdot 10^{-9} \cdot R_E + 1 \cdot 10^{-4}) \cdot U_Z^2 + (14 \cdot 10^{-8} \cdot R_E + 19 \cdot 10^{-5}) \cdot U_Z) \cdot 100\% + 0,26 \cdot \sqrt{U_Z \Omega})$

Additional uncertainty due to interference current for 3p + clamps function

(for 25 V and 50 V)

R_E	Uncertainty [Ω]
$\leq 50 \Omega$	$\pm(4 \cdot 10^{-2} \cdot R_E \cdot I_{zakl}^2)$
$> 50 \Omega$	$\pm(25 \cdot 10^{-5} \cdot R_E^2 \cdot I_{zakl}^2)$

Additional uncertainty due to interference current for double clamps function

R_E	Uncertainty [Ω]
$< 5 \Omega$	$\pm(5 \cdot 10^{-2} \cdot R_E^2 \cdot I_{zakl})$
$\geq 5 \Omega$	$\pm(2,5 \cdot 10^{-2} \cdot R_E^2 \cdot I_{zakl}^2)$

Additional uncertainty for the ratio of the resistance measured with clamps on a branch of a multiple earthing, to the resultant resistance the as a function of 3p + clamps.

R_C	Uncertainty [Ω]
$\leq 99,9 \Omega$	$\pm(5 \cdot 10^{-3} \cdot \frac{R_C}{R_w^2})$
$> 99,9 \Omega$	$\pm(9 \cdot 10^{-2} \cdot \frac{R_C}{R_w^2})$

$R_C[\Omega]$ is a value of resistance measured with clamps on the branch displayed by the device, whereas $R_w[\Omega]$ is a value of resultant resistance of multiply earthing.

10.3.5 Additional uncertainties according to IEC 61557-6 (RCD)

I_A, t_A, U_B

Significant parameter	Designation	Additional uncertainty
Position	E_1	0%
Supply voltage	E_2	0%
Temperature 0°C...35°C	E_3	0%
Resistance of electrodes	E_5	0%
Mains voltage 85%...110% U_n	E_8	0%

10.4 List of reference standards

- EN 61010-1:2010
- EN 61010-2-030:2010
- EN 61557-1:2007,-2, 3, 4, 5, 7:2007, -6:2007, -10:2013
- EN 60529:1991/A2:2013
- EN 61326-1:2013
- EN 61326-2-2:2013
- IEC 62752
- IEC 62955

11 Accessories

The current list of accessories can be found on the manufacturer's website.

11.1 Standard accessories

Standard set of equipment supplied by the manufacturer includes:

- MPI-535 meter
- set of test leads:
 - WS-03 adapter with START button with UNI-SCHUKO plug – **WAADAWS03**
 - 1.2 m leads, cat. III 1000 V with banana plugs – 4 pcs:
 - yellow – **WAPRZ1X2YEBB**
 - red – **WAPRZ1X2REBB**
 - blue – **WAPRZ1X2BUBB**
 - test lead on reel (banana plugs):
 - 15 m blue – **WAPRZ015BUBBSZ**
 - 30 m red – **WAPRZ030REBBSZ**
- USB cable – **WAPRZUSB**
- crocodile clip 1 kV 20 A (cat. III 1000 V) – 4 pcs:
 - yellow K02 – **WAKROYE20K02**
 - red K02 – **WAKRORE20K02**
 - blue K02 – **WAKROBU20K02**
- pin probe with banana socket (cat. III 1000 V) – 3 pcs:
 - yellow – **WASONYEOGB1**
 - red – **WASONREOGB1**
 - blue – **WASONBUOGB1**
- earth contact probe (rod), 30 cm – 2 pcs – **WASONG30**
- Z7 power supply – **WAZASZ7**
- mains cable (IEC C13 plug, 230 V) – **WAPRZLAD230**
- L2 carrying case – **WAFUTL2**
- L2 hanging strips (long 1,5 m and short 30 cm) – **WAPOZSZEKPL**
- Li-Ion 11,1 V 3,4 Ah battery – **WAAKU15**
- user manual
- factory calibration certificate

11.2 Optional accessories

Additionally, the following items that are not included in the scope of standard equipment may be purchased from the manufacturer or the distributors:

- General measurements

WS-04 adapter with UNI-SCHUKO angular plug (without triggering)

WAADAWS04



Foldable pin probe, 1 kV, 2 m (banana socket)

WASONSP2M



- Insulation resistance measurement

AutoISO-1000c adapter

WAADAAISO10C



PRS-1 resistance test probe

WASONPRS1GB



- Test lead red 1 kV (banana plugs)

5 / 10 / 20 m long

WAPRZ005REBB

WAPRZ010REBB

WAPRZ020REBB



- Test lead (banana plugs, on a reel)

25 m blue

WAPRZ025BUBBSZ



50 m yellow

WAPRZ050YEBBSZ



- Reel for test lead

WAPOZSZP1



- Earth contact test probe (rod)

Earth contact test probe (rod)
80 cm

WASONG80V2



L3 carrying case for 80 cm rods
WAFUTL3



- Test cramp (banana socket)

WAZACIMA1



- Measurement clamps

N-1 transmitting clamps
(Ø 52 mm)

WACEGN1BB



C-3 (Ø 52 mm) for grounding measurements

WACEGC3OKR



- Three-phase socket adapter 16 A

5-lead version
AGT-16P

WAADAAGT16P



4-lead version
AGT-16C

WAADAAGT16C



- Three-phase socket adapter 32 A

5-lead version
AGT-32P

WAADAAGT32P



4-lead version
AGT-32C

WAADAAGT32C



- Three-phase socket adapter 63 A

5-lead version
AGT-63P

WAADAAGT63P



- Industrial socket phase adapter

AGT-16T 16 A
WAADAAGT16T



AGT-32T 32 A
WAADAAGT32T



- LP-1 light meter probe with WS06 plug, class B, resolution from 0,1 lx

set with WS-06 adapter
WAADALP1KPL



only light meter probe with PS/2 plug
WAADALP1



- LP-10B light meter probe with WS06 plug, class B, resolution from 0,01 lx

set with WS-06 adapter
WAADALP10BKPL



only light meter probe with PS/2 plug
WAADALP10B



- LP-10A light meter probe with WS06 plug, class B, resolution from 0,001 lx

set with WS-06 adapter
WAADALP10AKPL



only light meter probe with PS/2 plug
WAADALP10A



- only WS-06 adapter with PS/2 socket

WAADAWS06



- Power supply

AZ-2 power supply adapter (IEC C7 plug / banana plugs)
WAADAAZ2



Cable for battery charging from car cigarette lighter socket (12 V)
WAPRZLAD12SAM



- TWR-1J - RCD breaker adapter testing

WAADATWR1J



- CS-1 cable simulator

WAADACS1





- Software Sonel Reports Plus. Supports creation of documentation after testing of electrical installation.

WAPROREPORTPLUS



- 4 GB microSD card
- Calibration certificate with accreditation

		
	N-1	C-3
	WACEGN1BB	WACEGC3OKR
Rated current	1000 A AC	1000 A AC
Frequency	30 Hz...5 kHz	30 Hz...5 kHz
Max. diameter of measured conductor	52 mm	52 mm
Minimum accuracy	—	≤0.3%
Battery power	—	—
Lead length	2 m	2 m
Measurement category	III 600 V	III 600 V
Ingress protection	IP40	

12 Positions of the meter's cover

The movable cover enables using the meter in various positions.

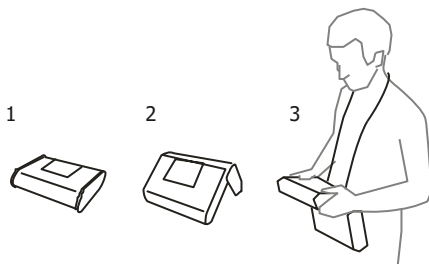

1 – Cover as the bottom of the meter

2 – Cover used as a support

3 – Cover in the position that enables convenient use of the meter suspended on the neck by means of hanging straps

13 Manufacturer

The manufacturer of the device and provider of guarantee and post-guarantee service:

SONEL S.A.

Wokulskiego 11

58-100 Świdnica

Poland

tel. +48 74 858 38 60

fax +48 74 858 38 09

E-mail: export@sonel.pl

Web page: www.sonel.pl



NOTE!

Service repairs must be performed only by the manufacturer.

14 Laboratory services

SONEL Testing and Calibration Laboratory has been accredited by the Polish Center for Accreditation (PCA) - certificate no. AP 173.

Laboratory offers calibration for the following instruments that are used for measuring electrical and non-electrical parameters.



AP 173

● METERS FOR MEASUREMENTS OF ELECTRICAL PARAMETERS

- voltage meters,
- current meters (including clamp meters),
- resistance meters,
- insulation resistance meters,
- earth resistance and resistivity meters,
- RCD meters,
- short-circuit loop impedance meters,
- power quality analyzers,
- portable appliance testers (PAT),
- power meters,
- multimeters,
- multifunction meters covering the functions of the above-mentioned instruments,

● ELECTRICAL STANDARDS

- calibrators,
- resistance standards,

● METERS FOR MEASUREMENTS OF NON-ELECTRICAL PARAMETERS

- pyrometers,
- thermal imagers,
- luxmeters.

The Calibration Certificate is a document that presents a relation between the calibration standard of known accuracy and meter indications with associated measurement uncertainties. The calibration standards are normally traceable to the national standard held by the National Metrological Institute.

According to ILAC-G24 „Guidelines for determination of calibration intervals of measuring instruments”, SONEL S.A. recommends periodical metrological inspection of the instruments it manufactures no less frequently than once every 12 months.

For new instruments provided with the Calibration Certificate or Validation Certificate at the factory, re-calibration should be performed within 12 months from the date of purchase, however, no later than 24 months from the date of purchase.



NOTE!

The person performing the measurements should be absolutely sure about the efficiency of the device being used. Measurements made with an inefficient meter can contribute to an incorrect assessment of the effectiveness of health protection and even human life.

NOTES

NOTES

MEASURING MESSAGES



NOTE!

The meter is designed for operation at rated phase voltages of 110 V, 115 V, 127 V, 220 V, 230 V and 240 V and phase-to-phase voltages of 190 V, 200 V, 220 V, 380 V, 400 V, 415 V.

Connecting voltage higher than allowed between any of the test terminals may damage the meter and cause a hazard to the user.

Measurement Zs

L-N!

U_{L-N} voltage is incorrect for making a measurement.

L-PE!

U_{L-PE} voltage is incorrect for making a measurement.

N-PE!

U_{N-PE} voltage exceeds allowable value of 50 V.



Phase connected to N terminal instead of L terminal (for example, exchange of L and N in the mains socket).

TEMPERATURE!

Maximum temperature of the meter is exceeded.

f!

Network frequency is outside the range of 45 Hz...65 Hz.

ERROR!

Measurement error. Correct result cannot be displayed.

Loop circuit malfunction!

The meter should be serviced.

U>500V!

and continuous audio signal

Before measurement, voltage at test terminals exceeds 500 V.

VOLTAGE!

The voltage on the tested object is not within the limits specified for the set rated voltage of the network U_n .

LIMIT!

Too low value of the prospective short circuit current I_k for the pre-set fuse and time of its triggering.

R_E measurement

VOLTAGE!

Too high voltage at the meter terminals.

H!

Interruption in the test probe circuit.

S!

Interruption in the voltage probe circuit.

R_E>1.99 kΩ

Measuring range is exceeded.

NOISE!

Signal / noise ratio is too low (interfering signal too large).

LIMIT!

Measurement uncertainty R_E due to the resistance of electrodes >30 %. (For calculating uncertainty, measured values are taken into account).



Interruption in measuring circuit or resistance of test probes is higher than 60 kΩ.

RCD measurement

U_B>U_L!

The touch voltage exceeds a preset U_L threshold value.

!

displayed on the right side of the result indicates a fault of RCD.

PE!

and continuous audio signal

Voltages between the contact electrode and PE conductor exceeds the allowable limit value of U_L .

R_{iso} measurement



and continuous audio signal

Voltage detected on terminals of the meter. Measurement is not possible.

NOISE!

Interference voltage occurs on the tested object. Measurement is possible but may be burdened with additional uncertainty.

LIMIT!

Current limit tripped. The symbol displayed during the measurement is accompanied by a continuous beep. If it is displayed after the measurement, it means that the measurement result was obtained during operation with a current limiting device (e.g. short circuit of the test object).



SONEL S.A.
Wokulskiego 11
58-100 Swidnica
Poland



+48 74 858 38 60
+48 74 858 38 00
fax +48 74 858 38 09

e-mail: export@sonel.pl
www.sonel.pl